

STATESMAN

kitchen appliances



F01754LFW / F01754LFS / F01754LFX
175CM HIGH 54CM WIDE LOW FROST
FRIDGE FREEZER WHITE / SILVER / DARK INOX

Instruction Manual

Please read these instructions carefully before use and retain for future reference.
Before switching on your appliance – always check for any damage that may have been caused in transit.

CONTENTS

Important Safety Instructions	3-5
Specification.....	6
Appliance Overview.....	7
Installation	8
Operating Instructions.....	9-10
Cleaning and Maintenance.....	11-12
Trouble Shooting Guide.....	13
Fuse Replacement	14
Disposal Information	14
Statesman Warranty Information.....	15

IMPORTANT SAFETY INSTRUCTIONS

Read and follow all the instructions even if you feel you are familiar with the product and find a place to keep this manual handy for future reference.

IMPORTANT: This product is intended for domestic use only; to store and freeze food products only. When using electrical appliances, basic safety precautions should always be followed:

- The operating voltage of the appliance is 220-240V at 50Hz. Check the voltage of the appliance matches the household voltage on the rating label and specification.
- Do not operate the appliance with a damaged cord or plug, after it malfunctions or has been dropped or damaged in any way. All electrical repairs must be carried out by a qualified electrician. Inadequate repairs may result in a major source of danger for the user and invalidate the warranty.
- Use of an extension cord is not recommended with this product.
- This appliance can be used by children aged from 8 years and above if they have been given supervision or instruction concerning the use of the appliance in a safe way and understand the hazards involved.
- Children aged from 3 to 8 years are allowed to load and unload this appliance.
- Children shall not play with the appliance and should be supervised.
- Keep the appliance and its cord out of the reach of children.
- Cleaning and user maintenance shall not be made by children.
- Keep all packaging materials away from children as there is a risk of suffocation.
- This appliance can be used by persons with reduced physical, sensory, or mental capabilities or lack of experience and knowledge if they have been given supervision or instruction concerning use of the appliance in a safe way and understand the hazards involved.
- Always unplug the appliance before attempting to move. When disconnecting from the electricity supply, pull the plug and not the cord.
- This product is for indoor use only.
- Do not store explosive substances such as aerosol cans with a flammable propellant in this appliance.
- The refrigerant of this product is R600a which is flammable. Ensure when moving the appliance or during installation that the cooling system does not get damaged.



WARNING: Risk of child entrapment.

Before disposal of the old appliance, make sure that any locking mechanisms have been broken off, doors have been removed but shelves have been left in so that children cannot easily climb inside. Also remove the plug so the appliance is unusable.



WARNING: Always keep the ventilation openings clear of obstruction. Should they become blocked, clear them straight away.





WARNING: Do not use mechanical devices or other means to accelerate the defrosting process, other than those recommended by the manufacturer.



WARNING: Do not damage the refrigerant circuit.

WARNING: Do not use other electrical appliances inside the appliance, unless approved for this purpose by the manufacturer.

 **WARNING:** Do not touch the light bulb if it has been on for a prolonged period as it could be hot.

 **WARNING:** When positioning the appliance, ensure that the supply cord is not trapped or damaged.

 **WARNING:** Do not locate multiple portable socket-outlets or portable power supplies at the rear of the appliance.

- During transportation and installation of the appliance, make sure that none of the components of the refrigerant circuit become damaged.
 - Avoid open flames and sources of ignition.
 - Thoroughly ventilate the room in which the appliance is installed.
- Do not modify or alter the specifications of the appliance in any way as this could cause a hazard and invalidate the warranty.
- This product is intended to be used in a household and similar applications such as:
 - staff kitchen areas in shops, offices, and other working environments;
 - farm houses and by clients in hotels, motels, and other residential type environments;
 - bed and breakfast type environments;
 - catering and similar nonretail applications.

 **WARNING:** Any electrical components (e.g., plug, power cord, compressor) must be replaced by a certified service agent or qualified electrician.

 **WARNING:** The light bulb supplied with this appliance is a special use bulb and is not suitable for domestic lighting.

- The power cord must not be lengthened or altered in any way.
- Make sure that the appliance is not positioned on or over the plug.
- Make sure that the power socket for the appliance is accessible once the appliance is installed.
- Do not pull the power cable, remove by pulling the plug.
- Do not use the plug socket if it is loose as there is a risk of electric shock.
- Do not operate the appliance without the lamp.
- The appliance is heavy, take care when moving.
- Do not touch items from the freezer compartment if your hands are damp/wet, as this can cause freezer burns.
- Avoid prolonged exposure to direct sunlight.
- It is not recommended to stand the appliance on a carpeted surface.
- Do not put hot/warm objects in the fridge/freezer.
- Do not place food items directly against the rear wall.
- Frozen foods must not be re-frozen once they have been thawed out.
- Always follow the storage specifications indicated by the food manufacturer.
- Do not place carbonated or fizzy drinks in the freezer compartment as this creates pressure in the container and may cause it to explode, resulting in damage to the appliance.

To avoid contamination of food, pay attention to the following:

- opening the door for long periods can cause a significant increase in temperature in the compartments of the appliance;
 - clean regularly, surfaces that can come in contact with food and accessible drainage systems;
 - clean water tanks if they have not been used for 48 hours;
 - flush the water system connected to a water supply if water has not been drawn for 5 days;
 - store raw meat and fish in suitable containers in the refrigerator so that it is not in contact with or cannot drip onto other food;
 - two-star frozen-food compartments are suitable for storing pre-frozen food, storing or making ice-cream and making ice cubes;
 - one-star, two-star and three-star compartments are not suitable for the freezing of fresh food
- ;- if the refrigerating appliance is left empty for long periods, switch off, defrost, clean, dry and leave the door open to prevent mould developing within the appliance.

WARNING: Any electrical repairs or servicing must be carried out by a qualified electrician. Inadequate repairs may result in a major source of danger for the user and invalidate the warranty. The appliance must be serviced by an authorised service centre and only genuine spare parts used.



TECHNICAL SPECIFICATION

Supplier Name / Trade Mark	Statesman
Model Number	F01754LFW / F01754LFX / F01754LFS
Category Type	Fridge Freezer
Energy Efficiency Class	E
Annual Energy Consumption	219kWh
Freezing Capacity	4.5kg/24hr Fridge Storage
Fridge Storage Volume (Litre)	154
Freezer Storage Volume (Litre)	100
Refrigeration System	Low Frost with Smart Frost Technology
Climate Class	N/ST
Noise Emission (dB)	41
Voltage (V)	220-240
Wattage Power (W)	219
Frequency (Hz)	50

Ambient Room Temperature Limits

Install this appliance at a location where the ambient temperature corresponds to the climate class indicated on the rating label of the appliance:

Class	Symbol	Ambient average temperature °C
Extended temperature	SN	+10 to +32
Temperature	N	+16 to +32
Subtropical	ST	+16 to +38
Tropical	T	+16 to +43

APPLIANCE OVERVIEW

1. Thermostat
2. Fridge Glass Shelves
3. Crisper Drawer Cover
4. Crisper Drawer
5. Freezer Drawers
6. Levelling Feet
7. Door Shelves

*This illustration is only for reference, for details please check your appliance.

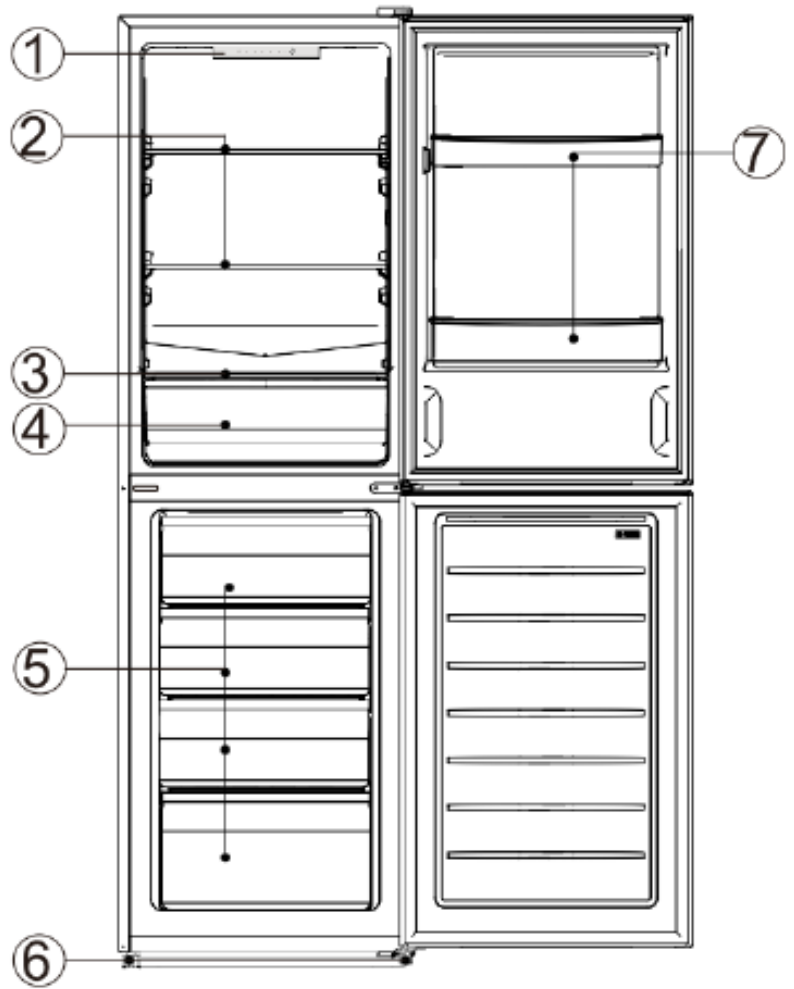

INSTALLATION

- The appliance must stand vertically on a flat, even surface. To level the appliance, use the levelling feet by turning them until the appliance is as level as possible.
- It is not recommended to stand the appliance on a carpeted surface.
- This appliance must be left to stand in an upright position for at least 4 hours before being switched on for the first time to allow the coolant gases time to settle after the appliance is in place.
- The appliance should not be placed near to sources of heat e.g. cookers, radiators, direct sunlight or in any unheated rooms e.g. garages, or outhouses, as extreme temperatures will affect the performance of your appliance.
- Never place the appliance in a wall recess, fitted cabinet or furniture as this will not allow adequate ventilation and cause a potential fire hazard.
- Allow 30mm of space at the top, 100mm on both sides, and 50mm to the rear of the refrigerator.

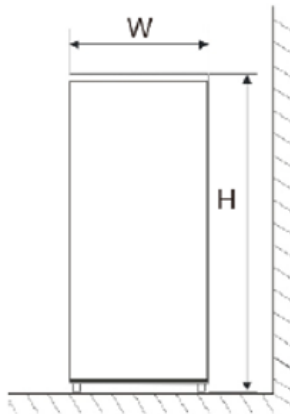

Fig. 1

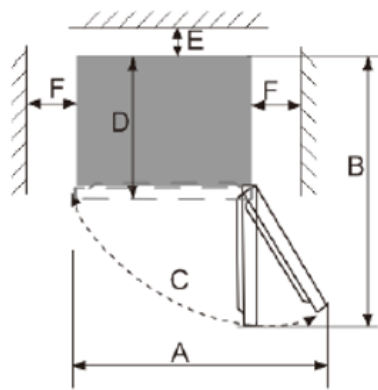

Fig. 2

W	D	H	A	B	C(°)	E	F
540	550	1760	910	1055	130±5	50	100

WARNING: It must be possible to disconnect the appliance from the mains power supply. The plug must be accessible after installation.

- Do not cover or block the vents or grills of your appliance.

Levelling the Unit

Adjust the two levelling feet at the front of the appliance.

If the unit is not level, the doors and magnetic seal alignments will not be sealed correctly.



OPERATING INSTRUCTIONS

IMPORTANT: Before using the appliance for the first time, wash the interior and all the internal accessories with lukewarm water and some neutral soap to remove the typical smell of a new product, then dry thoroughly.

IMPORTANT: Do not use abrasive detergents or powders, as they will damage the finish of the appliance.

Setting the Temperature in the Fridge

The temperature of the refrigerator is controlled by the Control Panel mounted in the fridge compartment.

- The refrigerator temperature settings are as follows:

5→4→3→2→1→FASTCOOL→5

COLDEST  COLD	5	When the user needs a colder temperature.
	4	
	3	When in normal use.
	2	When the user does not need a colder temperature.
	1	

- The mode '3' is recommended and mode '5' is not recommended to avoid frozen food.
- You can set the 'Fast Cool' function to quickly cool or freeze foods. The 'Fastcool' function will exit automatically after 26 hours or be disabled manually.



- If the indicator light '5' or '3' or '1' starts blinking, this will indicate that the refrigerator has broken down. Please contact our Customer Service Department.

Food Storage

Due to the cold air circulation in the refrigerator, the temperature of each area is different.

- The fresh food compartment is suitable for the storage of such foods as cooked foods, drinks, eggs, milk, fruit juice etc.
- The Crisper Drawer is suitable for fruit and vegetables.
- The freezer compartment is suitable for the storage of ice cream, frozen food, and foods to be preserved for a long time.

Installing and Removing the Fridge Shelves

When removing the shelf, lift it up first, and then pull it out. When installing the shelf, place it in position before lowering it down.

For the 2-section shelf, push the first section to the back and then pull the second section out. Keep the rear flange upwards to prevent the food from touching the rear wall.

When taking out or putting in the shelves, hold firmly and handle with care to avoid damage.

Crisper Drawer

Pull out the Crisper Drawer for access to the food.

Ice-making Box

Place the ice-making box in the upper position of the freezer compartment.

Please Note: No bananas, onions, potatoes, or garlic should be kept in the refrigerator.

Using your Appliance

- When using for the first time or after a period of non-use, plug in and set the temperature control panel to the coldest setting. Run to allow the appliance to reach an adequate temperature. Once reached the panel can then be set to the correct temperature.
- The maximum amount of food that can be frozen in 24 hours is specified on the Rating Label.
- Only freeze top quality, fresh and thoroughly cleaned foods.
- Prepare food in small portions to enable it to be rapidly and completely frozen and to make it easier to thaw the quantity required.
- Wrap the food in aluminium foil or polythene and make sure the packages are airtight.
- Do not allow fresh or unfrozen food to touch items that are already frozen, this will avoid raising the temperature of frozen items and avoid thawing. It will also help fresh food to freeze quicker.
- Lean foods store better and longer than fatty ones, salt reduces the storage life of food.
- Ice cubes, if consumed immediately after removal from the freezer, can possibly cause freezer burns to the skin.
- It is advisable to show the freezing date on each individual pack to enable you to keep tabs of the storage time.
- Make sure any shop bought frozen foods were adequately stored by the retailer and were transferred from the shop to the freezer in the shortest possible time.
- Do not open the door frequently or leave it open longer than necessary.
- Once defrosted, food deteriorates rapidly and cannot be refrozen.
- Do not exceed the storage period indicated by the food manufacturer.

CLEANING & MAINTENANCE

IMPORTANT: Switch off the electrical supply and remove the plug from the mains socket before carrying out cleaning or maintenance.

WARNING: Do not use abrasive cloths, powders, household cleaners, bleach, or wax polish to clean the appliance as these can leave a smell in the appliance and can damage the exterior.

Before First Use

Before using the appliance for the first time, wash the interior and all internal accessories with lukewarm water and some neutral soap to remove the typical smell of a brand-new product, then dry thoroughly.

IMPORTANT: Do not use detergents or abrasive powders, as these will damage the finish.

Interior

1. The interior of the refrigerator should be cleaned regularly to avoid odour.
2. Remove all food from the appliance and cover to help keep it cool.
3. Remove all the drawers and shelves carefully from the appliance and wash in warm clean water with a soft cloth and dry thoroughly. Never replace the drawers when still wet.
4. Use a soft cloth or sponge to clean the inside of the refrigerator, with two tablespoons of baking soda and a quart of warm water. Rinse with water and wipe clean.
5. Open the door and allow the interior to dry naturally before replacing shelves and the salad drawer. The appliance should be fully dry before it is switched back on.
6. Plug in, switch on and allow the temperature in the appliance to drop back to an adequate temperature.
7. Replace the food in the appliance.

Exterior

Use a clean, soft cloth dampened in soapy water to wipe the exterior surface of the appliance and then dry thoroughly. Use a vacuum cleaner to remove dust from underneath the appliance and from around the compressor which is situated at the back of the appliance. Do this regularly to maintain adequate ventilation. Be careful not to damage the coolant system.

Door Seal

Use a clean, damp soft cloth to wipe the door seal and in between the creases, take care to avoid damaging the door seal as this will affect the performance of your appliance.

Drainage Channel

The drainage channel must be cleaned regularly to prevent a build-up of impurities; this can be found on the interior back wall of your appliance. Use a damp clean cloth to wipe the channel clean, then use a pipe cleaner or similar flexible object to clean the drainage hole to prevent blockages.

Replace the Bulb

The internal light is an LED type. To replace the bulb, please contact a qualified electrician.

Going Away

If you are going away and do not want to leave the appliance on, switch off at the mains socket and remove the plug ensuring not to pull the cord. Remove any food and follow the cleaning instructions in the “Cleaning and Maintenance” section.

IMPORTANT: Leave the door ajar as this will prevent odours and mould accumulating in the appliance and will allow the appliance to dry completely.

Power Cut

In the event of a power cut keep the appliance door closed to maintain the temperature inside.

TROUBLE SHOOTING GUIDE

If you are having problems with your appliance, please use our trouble shooting guide below. If you are unable to resolve the issue using this guide please ring our Customer Service Department on 01473 277 508. Please have the model code and purchase information available.

Problem	Possible Cause	Solution
Appliance does not work.	Temperature regulation dial is set to 'OFF'.	Set the dial to another setting to switch on the appliance.
	Mains plug is not plugged in or is loose.	Insert mains plug correctly.
	Fuse has blown or is defective.	Check fuse, replace if necessary.
	Socket is defective.	Mains malfunctions are to be corrected by an electrician.
The food is too warm.	Temperature is not properly adjusted.	Refer to the Temperature Setting section.
	Door was open for an extended period.	Open the door only as long as necessary.
	A large quantity of warm food was placed in the appliance in the last 24 hours.	Turn the temperature regulation to a colder setting temporarily and do not over fill with food.
	The appliance is near a heat source.	Please refer to the Installation section.
Appliance cools too much.	Temperature is set too cold.	Turn the temperature regulation dial to a warmer setting temporarily.
Unusual noises.	Appliance is not level.	Re-adjust the feet.
	The appliance is touching the wall or other objects.	Move the appliance slightly.
	A component, e.g. a pipe, on the rear of the appliance is touching another part of the appliance or the wall.	If necessary, carefully bend the component out of the way.
Water on the floor.	Warer drain hole is blocked.	Clean the drian hole with a cleaner.
Heavy build up of frost on the door seal.	Door seal is not air tight.	Carefully warm the leaking sections of the door seal with a hair dryer (on a cool setting). At the same time shape the warmed door seal by hand such that it sits correctly.

MAINS PLUG FUSE REPLACEMENT

Fuse Replacement (Class I)

This appliance must be earthed. Remove the fuse cover with a small flat head screw driver. Take out the fuse and replace with a new fuse of the same Amp. Replace the fuse cover and push back into place.

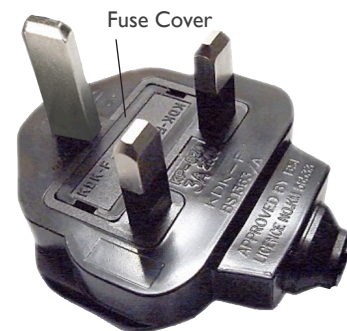

DISPOSAL INFORMATION

The European Directive 2012/19/EU on Waste Electrical and Electronic Equipment (WEEE), requires that old household electrical appliances must not be disposed of in normal unsorted municipal waste.

Old appliances must be collected separately in order to optimise the recovery and recycling of the materials they contain and reduce the impact on human health and the environment.

The crossed out “wheeled bin” symbol on the product reminds you of your obligation, that when you dispose of the appliance it must be separately collected. Consumers should contact their local authority or retailer for information concerning the correct disposal of their old appliance.

Doors and lids of the refrigeration appliance should be removed before disposal in the landfill, to avoid children or animals getting trapped inside.



STATESMAN WARRANTY/GUARANTEE TERMS & CONDITIONS

THANK YOU FOR CHOOSING STATESMAN

As a valued customer we would like to offer you a **FREE 2-year warranty** to cover your product against any electrical or mechanical defects.

This means that in the unlikely event you develop a fault or problem with your product we will happily repair or replace the item free of charge.

To qualify for the guarantee, the product must be used for domestic household use only and in accordance with the instructions in the user manual. Any misuse of the product will result in the warranty being void.

The guarantee does not cover accidental damage, misuse, neglect, tampering or incorrect adjustment or installation.

The guarantee will be rendered invalid if the product is resold, has had its serial number or rating label removed (or has an invalid serial number or rating label), or if an unauthorised person has carried out any repairs or alterations.

The warranty does not cover accessories or consumable parts that require replacement under normal use. This includes shelving, dials, filters, belts and trays etc.

In the unlikely event of a breakdown please refer to the Troubleshooting Guide in your user manual and check all plugs, fuses and the electricity supply.

If you still require assistance, please contact our Customer Service Department on **01473 277 508** or write to us at the following address:

Customer Service Department
38 Bluestem Road, Ransomes Industrial Estate, Ipswich, IP3 9RR

Please quote the Product Code and the PO number on the rating label and give details of the exact fault. We will then decide whether to replace the item.

IMPORTANT NOTE: Before we arrange the replacement, you will be required to return a copy of your proof of purchase. Please retain your original.

If an item is replaced within the agreed warranty period, the warranty for the replacement item will be calculated from the purchase date of the original.

In the event that the product is inspected, and no fault is found, or the product is not within the guarantee period you will be charged for the repair and any carriage costs.

STATESMAN
kitchen appliances

**38 Bluestem Road, Ransomes Europark, Ipswich, IP3 9RR
Castle Electrical Factors Ltd., Dundalk, A91 KA9R, IR**

01473 277 508