

STATESMAN

kitchen appliances



FD10PWE 45CM SLIMLINE 10 PLACE DISHWASHER WHITE

Instruction Manual

Made in China

Serial number:

Please read these instructions carefully before use and retain for future reference.
Before switching on your appliance – Always check for any damage that may have been caused in transit.

CONTENTS

Important Safety Instructions	3-5
Product Information Sheet (EN60436).....	6
Appliance Overview.....	7
Control Panel.....	8-9
Installation	10-13
Prior to Using Your Dishwasher for the First Time	13-18
Recommended Loading of Racks.....	19-22
Wash Cycle Table	23
Operating Instructions.....	24-25
Cleaning and Maintenance.....	26-29
Troubleshooting.....	30-32
Error Codes	32
Mains Plug Fuse Replacement.....	33
Disposal.....	33

IMPORTANT SAFETY INSTRUCTIONS

Read and follow all of the instructions even if you feel you are familiar with the product, and find a place to keep this manual handy for future reference.

If the appliance is sold, given away or moved, make sure the instruction manual is kept with the machine.

Important: This product is intended for domestic indoor use only.

When using electrical appliances, basic safety precautions should always be followed:

1. All electrical repairs must be carried out by a qualified electrician. Inadequate repairs may result in a major source of danger for the user and invalidate the warranty.
2. Do not operate the appliance with a damaged cord or plug, after it malfunctions or has been dropped or damaged in any way.
3. This appliance is equipped with a connecting cable and earthed plug for connection to 220-240V at 50Hz. Check the voltage of the appliance matches the household voltage on the rating label and specification for further details.
4. This appliance must be earthed.
5. This appliance is not intended for use by persons (including children) with reduced physical, sensory or mental capabilities, or lack of experience and knowledge.
6. Cleaning and user maintenance shall not be made by children
7. Keep the appliance and its cord out of reach of children.
8. Children shall not play with the appliance.
9. The appliance must be used to wash domestic crockery in accordance with the instructions in this manual.
10. Always unplug the appliance before attempting to move. When disconnecting from the electricity supply, pull the plug and not the cord.

11. When installing the appliance to the water supply ensure that the new supplied hose set is used.
12. Before using the appliance ensure that all packaging materials are removed.
13. Do not abuse, sit on, or stand on the door or dish rack of the dishwasher.
14. The door should not be left open as it may create a dangerous obstacle.
15. Do not open the door of the appliance when it is running unless necessary; be cautious of hot steam or light spray of water.
16. The maximum number of place settings is shown in the specification sheet.
17. Use only detergent and rinse additives designed for automatic dishwashers.
18. Keep detergent and rinse aid out of reach of children.
19. Do not wash plastic items unless they are marked dishwasher safe.
20. When loading items to be washed:
 - 1) Locate sharp items so that they are not likely to damage the door seal
 - 2) Knives and other utensils with sharp edges must be placed either with the points/blades facing downwards in the cutlery basket or placed horizontally in the upper rack.
21. This appliance is intended to be used in the household and/or similar applications such as:
 - staff kitchen areas in shops, offices and other working environments
 - farm houses
 - by clients in hotels, motels and other residential type environments
 - bed and breakfast type environments
22. Keep packaging out of reach of children.
23. To protect against the risk of electrical shock, do not immerse the unit, cord or plug in water or other liquid.

24. Please unplug before cleaning and performing maintenance on the appliance.
25. Do not operate your dishwasher unless all interior panels are properly in place.
26. Open the door very carefully if the dishwasher is operating, there is a risk of water squirting out.
27. Do not place any heavy objects on or stand on the door when it is open. The appliance could tip forward.
28. The appliance needs to be connected to the main water valve using new hose sets. Old sets should not be reused.
29. Do not, under any circumstances, cut or remove the earthing connection from the power cord.
30. Some dishwasher detergents are strongly alkaline. They can be extremely dangerous if swallowed. Avoid contact with the skin and eyes and keep children away from the dishwasher when the door is open.
31. Check that the detergent powder is empty after completion of the wash cycle.
32. For unmarked plastic items which do not show to be dishwasher safe, check the manufacturer's recommendations.
33. Never use soap, laundry detergent, or hand washing detergent in your dishwasher.
34. If the supply cord is damaged, it must be replaced by the manufacturer or a qualified technician in order to avoid a hazard.
35. During installation, the power supply must not be bent or flattened.
36. Do not tamper with the controls.
37. To save energy when in stand by mode, the appliance will switch off automatically when there is no operation within 30 minutes.

PRODUCT INFORMATION SHEET (EN60436)

Supplier's name or trade mark: Statesman				
Supplier's address (*):				
Model identifier: FD10PWE				
General product parameters:				
Parameter	Value	Parameter	Value	
Rated capacity ^(a) (ps)	10	Dimensions in cm	Height	84,5
			Width	44,8
			Depth	61,0
EEL ^(a)	55,9	Energy efficiency class ^(a)	E ^(c)	
Cleaning performance index ^(a)	1,13	Drying performance index ^(a)	1,07	
Energy consumption in kWh [per cycle], based on the eco programme using cold water fill. Actual energy consumption will depend on how the appliance is used.	0,755	Water consumption in litres [per cycle], based on the eco program. Actual water consumption will depend on how the appliance is used and on the hardness of the water.	9	
Program duration ^(a) (h:min)	3:55	Type	Free standing	
Airborne acoustical noise emissions ^(a) (dB(A) re 1 pW)	49	Airborne acoustical noise emission class ^(a)	C ^(c)	
Off-mode (W)	0,49	Standby mode (W)	N/A	
Delay start (W) (if applicable)	1,00	Networked standby (W) (if applicable)	N/A	
Minimum duration of the guarantee offered by the supplier (b):				
Additional information:				
Weblink to the supplier's website, where the information in point 6 of Annex II to Commission Regulation (EU) 2019/2022 ⁽¹⁾ ^(c) is found:				
^(a) for the eco program. ^(b) changes to these items shall not be considered relevant for the purposes of paragraph 4 of Article 4 of Regulation (EU) 2017/1369. ^(c) if the product database automatically generates the definitive content of this cell the supplier shall not enter these data.				
⁽¹⁾ Commission Regulation (EU) 2019/2022 of 1 October 2019 laying down eco design requirements for household dishwashers pursuant to Directive 2009/125/EC of the European Parliament and of the Council amending Commission Regulation (EC) No 1275/2008 and repealing Commission Regulation (EU) No 1016/2010 (see page 267 of this Official Journal).				

APPLIANCE OVERVIEW

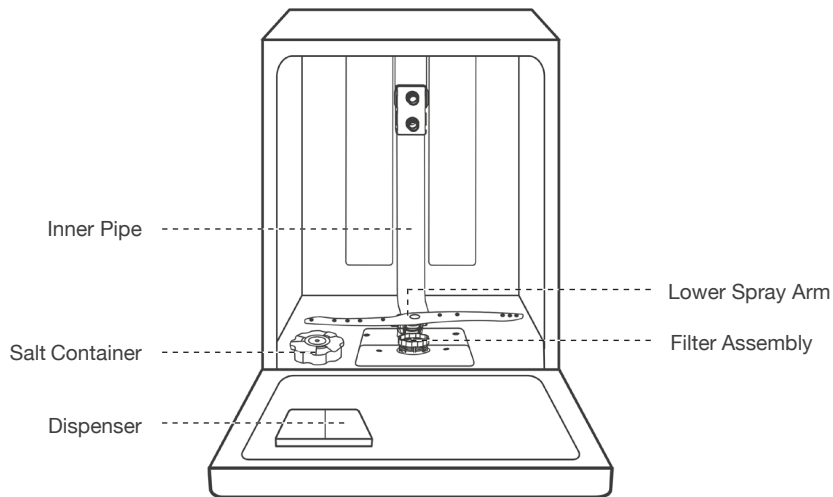

Cutlery Basket



Upper Basket

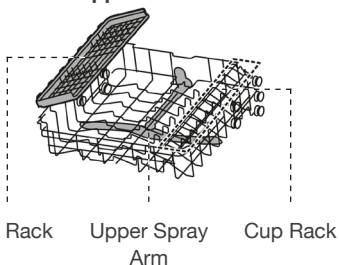

Lower Basket

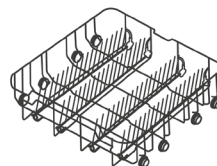

TECHNICAL INFORMATION

Height (H)	845 mm
Width (W)	448 mm
Depth (D1)	610 mm (with the door closed)
Depth (D2)	1175 mm (with the door opened 90°)

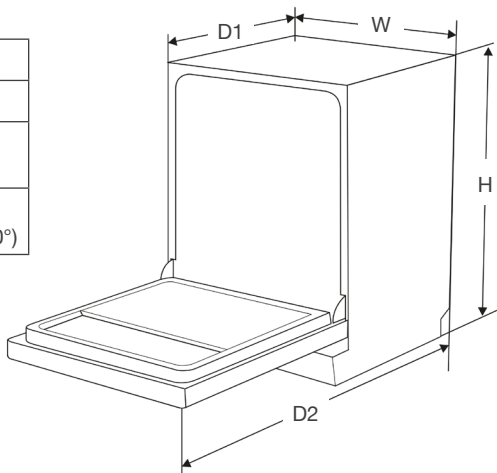



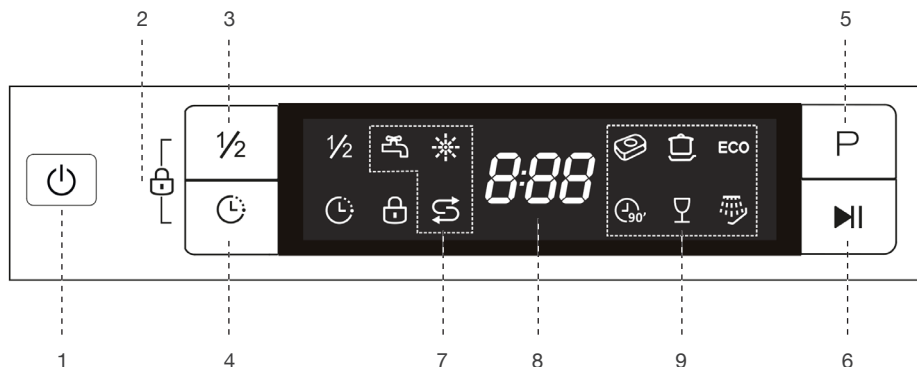









CONTROL PANEL



Operation (Button)

(1) Power	Press this button to turn on your dishwasher, the screen lights up.
(2) Child Lock	This option allows you to lock the buttons on the control panel - except the Power button - so that children cannot accidentally start the dishwasher. To lock or unlock the buttons on the control panel, press and hold the Half-load button + Delay button for 3 seconds simultaneously. When pressing this button, the corresponding indicator will be lit.
(3) Half-Load	For small loads, you may use just the upper or lower rack to save energy. Each press of the Half Load button cycles between upper rack only and lower rack only. When pressing this button, the corresponding indicator will be lit.
(4) Delay	Press this button to set how long the washing is to be delayed. You can delay the start of washing up to 24 hours. One press on this button delays the start of washing by one hour. When pressing this button, the corresponding indicator will be lit.
(5) Program	Select the appropriate washing program, the selected program indicator will be lit.
(6) Start / Pause	To start the selected washing program or pause it when the dishwasher is working.

Display

(7) Warning Indicator	 Tap If the “  ” indicator is lit, it means the tap is closed.
	 Rinse Aid If the “  ” indicator is lit, it means the dishwasher is low on dishwasher rinse aid and requires a refill.
	 Salt If the “  ” indicator is lit, it means the dishwasher is low on dishwasher salt and needs to be refilled.
(8) Screen	To show the remaining time, delay time, error code etc.
(9) Program Indicator	 All in one For soiled loads, use multi functional detergent.
	 Intensive Heavily soiled items include pots and pans. With dried on food.
	 ECO This is the standard program suitable for soiled loads, such as pots, plates, glasses and lightly soiled pans.
	 90 Min For soiled loads that need quick wash.
	 Glass For lightly soiled crockery and glass.
	 Soak To rinse dishes that you plan to wash later that day.

INSTALLATION

The dishwasher meets the requirements set out by the regulations in force concerning safety and electrical equipment.



Warning: If the appliance must be moved at any time, keep it in an upright position; if absolutely necessary, it may be tilted onto its back.



Any technical checks should be conducted exclusively by a trained and authorised technician: Repairs carried out by unauthorised persons will invalidate the guarantee, as well as posing a potential hazard to the user.



The manufacturer declines all responsibility for damage to persons or property resulting from failure to observe the precautions, from tampering with even a single component or from the use of non-original spare parts.



Disconnect electrical power before installing dishwasher. Failure to do so could result in death or electrical shock.



The installation of the pipes and electrical equipment should only be done by a qualified technician.

Positioning and Levelling

- Position the dishwasher on a level sturdy floor. If the floor is uneven, the front feet of the appliance may be adjusted until it reaches a horizontal position. If the appliance is levelled correctly, it will be more stable and much less likely to move or cause vibrations and noise while it is operating.
- Place the dishwasher so that its sides or back panel are in contact with the adjacent cabinets or the wall. This appliance can also be recessed under a single worktop.

Water Supply and Drain

Cold Water Connection

Connect the cold water supply hose to a threaded 3/4(inch) connector and make sure that it is fastened tightly in place.

If the water pipes are new or have not been used for an extended period of time, let the water run to make sure that the water is clear.

This precaution is needed to avoid the risk of the water inlet being blocked and damaging the appliance.

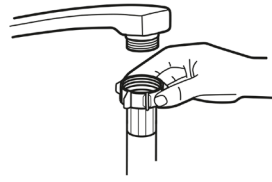

Ordinary Supply Hose



Safety Supply Hose

About the Safety Supply Hose

The safety supply hose consists of double walls. The hose's system guarantees intervention if the supply hose breaks or if the air space between the supply hose itself and the outer corrugated hose is full of water.



Warning: A hose that attaches to a sink spray can burst if it is installed on the same water line as the dishwasher. If your sink has one, it is recommended that the hose be disconnected and the hole plugged.

How to Connect the Safety Supply Hose

1. Pull the safety supply hoses completely out from storage compartment located at rear of dishwasher.
2. Tighten the screws of the safety supply hose to the faucet with thread 3/4inch.
3. Turn on the water fully before starting the dishwasher.

How to Disconnect the Safety Supply Hose

1. Turn off the water.
2. Unscrew the safety supply hose from the tap.

Connection of Drain Hoses

Insert the drain hose into a drain pipe with a minimum diameter of 4 cm, or let it run into the sink, making sure to avoid bending or crimping it. The height of drain pipe must be less than 1000mm. The free end of the hose must not be immersed in water to avoid back flow.

! Please securely fix the drain hose in either position A or position B

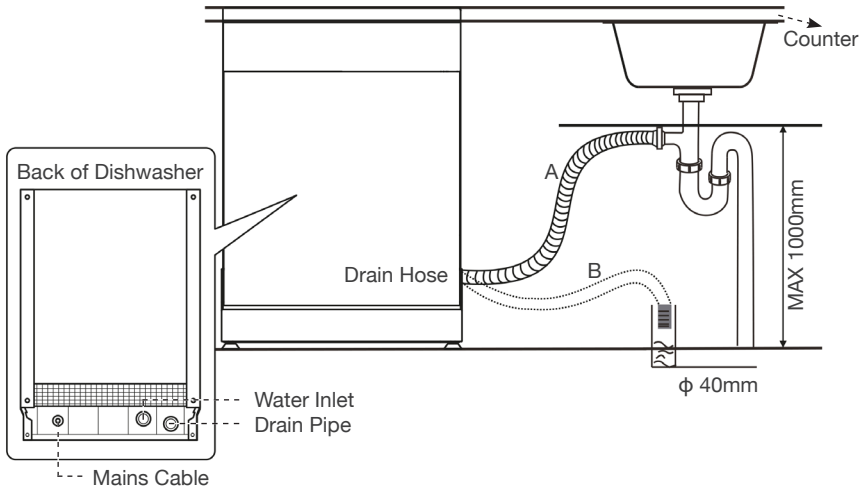

How to Drain Excess Water from Hoses

If the sink is 1000mm higher from the floor, the excess water in the hoses cannot be drained directly into the sink. It will be necessary to drain excess water from the hoses into a bowl or suitable container that is held outside and lower than the sink.

Water Outlet

Connect the water drain hose. The drain hose must be correctly fitted to avoid water leaks. Ensure that the water drain hose is not kinked or squashed.

Extension Hose

If you need a drain hose extension, make sure to use a similar drain hose. It must be no longer than 4 meters; otherwise the efficiency of the dishwasher will be reduced.

Syphon Connection

The waste connection must be at a height less than 1000mm from the bottom of the dish. The water drain hose should be fixed.



WARNING: HAZARDOUS VOLTAGE!

Under no circumstances should the water inlet hose be cut as it contains live electrical parts.

Electrical Connection

Before inserting the plug into the electrical socket, make sure that:

- The socket is earthed and complies with current regulations;
- The socket can withstand the maximum load of the appliance as shown on the Rating Label
- The power supply voltage falls within the values indicated on the Rating Label.
- The socket is compatible with the plug of the appliance. If this is not the case, ask an authorised technician to replace the plug).
- Do not use extension cables or multiple sockets.
- Improper connection of the equipment-earthing conductor can result in the risk of an electric shock.
- Do not modify the plug provided with the appliance.



Once the appliance has been installed, the power supply cable and the electrical socket should be easily accessible. The cable should not be bent or compressed.

PRIOR TO USING YOUR DISHWASHER FOR THE FIRST TIME

Water Softener

The water softener must be set manually, using the water hardness dial.

The water softener is designed to remove minerals and salts from the water, which would have a detrimental or adverse effect on the operation of the appliance.

The more minerals there are, the harder your water is.

The softener should be adjusted according to the hardness of the water in your area. Your local water authority can advise you on the hardness of the water in your area.

The hardness of the water varies from place to place. If hard water is used in the dishwasher, deposits will form on the dishes and utensils.

The appliance is equipped with a special softener that uses a salt container specifically designed to eliminate lime and minerals from the water.

Adjusting Salt Usage

The dishwasher is designed to allow for adjustment in the amount of salt used based on the hardness of the water. This is intended to optimise the amount of salt used.

Please follow the steps below for adjustment in salt used.

1. Switch on the appliance;
2. Press the Start/Pause button for more than 5 seconds within 60 seconds of the appliance being switched on to start the water softener mode;
3. Press the Program button to select the correct setting for your local environment, the sets will change in the following sequence:
H1->H2->H3->H4->H5->H6;
4. Press the Power button to end the set up model.

Water Hardness				Water Softener Level	Salt Consumption (gram/cycle)
German °dH	French °fH	British °Clarke	Mmol/l		
0 - 5	0 - 9	0 - 6	0 - 0.94	H1	0
6 - 11	10 - 20	7 - 14	1.0 - 2.0	H2	9
12 - 17	21 - 30	15 - 21	2.1 - 3.0	H3	12
18 - 22	31 - 40	22 - 28	3.1 - 4.0	H4	20
23 - 34	41 - 60	29 - 42	4.1 - 6.0	H5	30
35 - 55	61 - 98	43 - 69	6.1 - 9.8	H6	60

1°dH=1.25 °Clarke=1.78 °fH=0.178mmol/l The manufactory setting: H3 Contact your local water board for information on the hardness of your water supply.

Loading the Salt

Always use salt intended for dishwasher use.

The salt container is located beneath the lower basket and should be filled as explained in the following:

Warning: Only use salt specifically designed for dishwashers use!



Every other type of salt not specifically designed for dishwasher use, especially table salt, will damage the water softener. In the scenario that damage is caused by the use of unsuitable salt the manufacturer does not give any warranty and is not liable for any damages caused.

Only fill with salt before running a cycle.



This will prevent any grains of salt or salty water, which may have been spilt, remaining on the bottom of the machine for any period of time, which may cause corrosion.

Please follow the steps below for adding dishwasher salt:

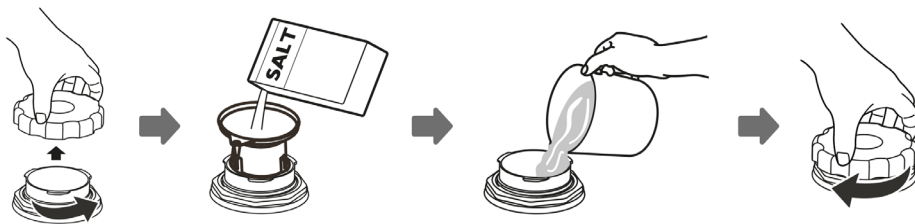

1. Remove the lower basket and unscrew the reservoir cap.
2. Place the end of the funnel (supplied) into the hole and pour in about 1.5kg of dishwasher salt.
3. Fill the salt container to its maximum limit with water. It is normal for a small amount of water to come out of the salt container.
4. After filling the container, screw the cap back on tightly.
5. The salt warning light will turn off when the salt container has been filled with salt.
6. Immediately after filling the salt into the salt container, a washing program should be ran (it is suggested this is a short program). Otherwise the filter system, pump or other important parts of the machine may be damaged by the salty water. This will also void the warranty.

Note: The salt container must only be refilled when the salt warning light () in the control panel comes on. Depending on how well the salt dissolves, the salt warning light may still be on even of the salt container has been filled. If salt has spilled, run a soak or quick program to remove it.

Function of the Rinse Aid

The rinse aid is released during the final rinse to prevent water from forming droplets on your dishes, which can leave spots and streaks. It also improves drying by allowing water to roll off the dishes. Your dishwasher is designed to use liquid rinse aids.



Warning: Only use branded rinse aid for dishwasher. Never fill the rinse aid dispenser with any other substances (e.g. dishwasher cleaning agent, liquid detergent). This will damage the appliance.

When to Refill the Rinse Aid Dispenser

If the rinse-aid warning light () on the control panel is not on, you are able to estimate the amount left from optical level indicator located next to the cap. When the rinse-aid container is full, the indicator will be dark. The size of the dark dot decreases as the rinse-aid diminishes. You should never let the rinse aid level be less than 1/4 full.

As the rinse aid diminishes, the size of the black dot on the rinse aid level indicator changes, as illustrated below.

 Full  3/4 Full  1/2 Full  1/4 Full  Empty

Function of Detergent

The chemical ingredients that compose the detergent are necessary to remove and dispense all dirt out of the dishwasher.



Warning: Proper Use of Detergent. Only use detergent specifically made for dishwashers. Keep your detergent fresh and dry. Don't put powdered detergent into the dispenser until you are ready to wash dishes.

Keep dishwasher detergent out of the reach of children.

Filling the Rinse Aid Reservoir

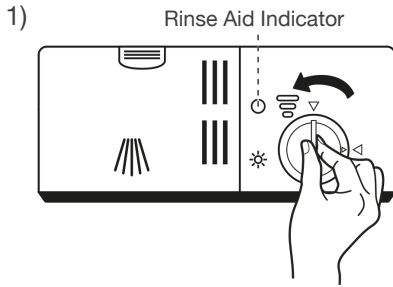

To open the dispenser, turn the cap to the “open” (left) arrow and lift it out.

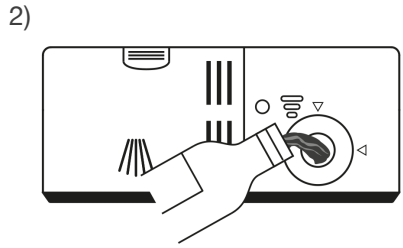

Carefully pour in the rinse-aid into its dispenser, whilst avoiding it to overflow.

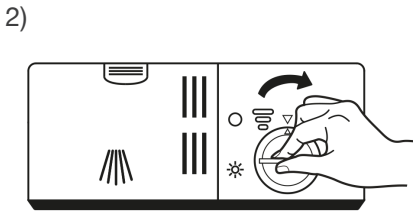

Replace the cap by inserting it so that it is aligned with “open” arrow and turning it to the closed (right) arrow.

Note: Clean up any spilled rinse aid with an absorbent cloth to avoid excessive foaming during the next wash.

Adjusting the Rinse Aid Reservoir

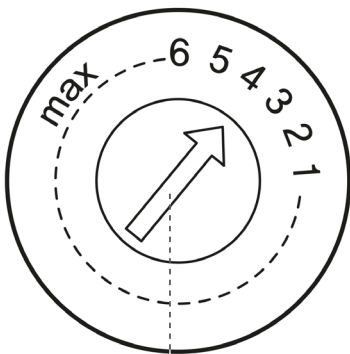

Adjust Lever (Rinse)

The rinse aid reservoir has six settings. Both the recommended setting and the factory setting is “4”. If the dishes are not drying properly or are spotted, adjust the dial to the next number up until your dishes are spot-free. Reduce it if there are sticky white stains on your dishes or a bluish film on glassware or knife blades.

Filling the Rinse Aid Reservoir

1) Push Latch to Open

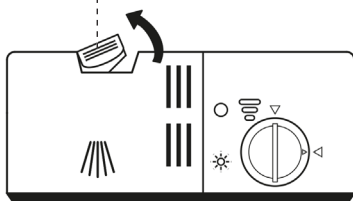

Press the release catch on the detergent dispenser to open the cover.

3)

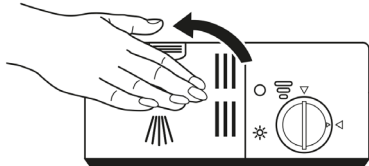

Close the cover and press down until it locks into place.

Note: Please note the detergent manufacturer's recommendations for the amount to use. This may differ depending on which brand you use.

2)

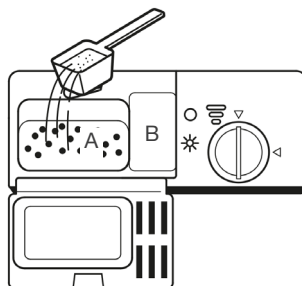

Add detergent into the larger cavity (A) for the main wash cycle . For more heavily soiled wash loads, also add some detergent into the smaller cavity (B) for the pre-wash cycle .

RECOMMENDED LOADING OF RACKS

For best performance of the dishwasher, follow these loading guidelines:

- Scrape off any large amounts of leftover food. Soften remnants of burnt food in pans.
- It is not necessary to rinse the dishes under running water.
- Place objects in the dishwasher in following way:
 - Items such as cups, glasses, pots/pans, etc. are faced downwards.
 - Curved items, or ones with recesses, should be loaded on a slant so that water can run off.
 - All items are stacked securely and cannot tip over.
 - All utensils are placed in the way that the spray arms can rotate freely during washing.
 - Dishes and items of cutlery must not lie inside one another, or cover each other.
 - To avoid damage to glasses, they must not touch.
 - Load large items which are most difficult to clean into the lower basket.
 - The upper basket is designed to hold more delicate and lighter dishware such as glasses, coffee and tea cups
 - Long and/or sharp items of cutlery such as carving knives must be positioned horizontally in the upper basket.
 - Please do not overload your dishwasher. This is important for good results and for reasonable consumption of energy.

NOTE: Very small items should not be washed in the dishwasher as they could easily fall out of the basket

When removing clean dishes, it is recommended that you empty the lower rack first and then the upper rack to prevent water dripping from the upper rack to the lower rack.

Loading Instructions

Upper Basket

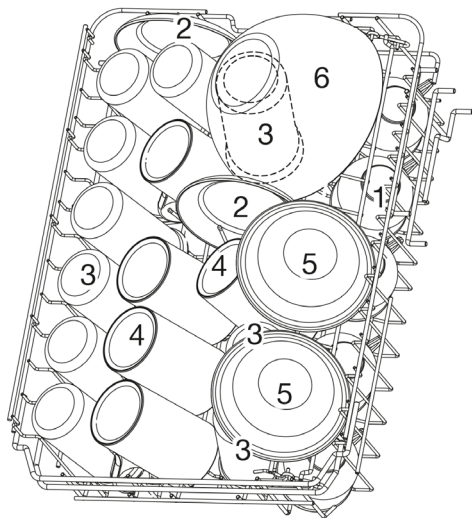

Number	Item
1	Cups
2	Saucers
3	Glasses
4	Mugs
5	Dessert Bowls
6	Glass Bowl

Lower Basket

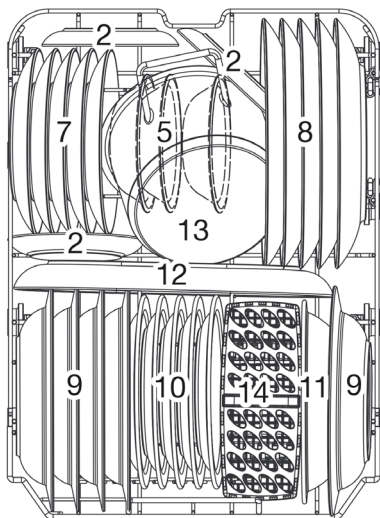

Number	Item
7	Dessert Plates
8	Dinner Plates
9	Soup Plates
10	Melamine Dessert Plates
11	Melamine Bowl
12	Oval Platter
13	Small Pot
14	Cutlery Basket

Cutlery Rack

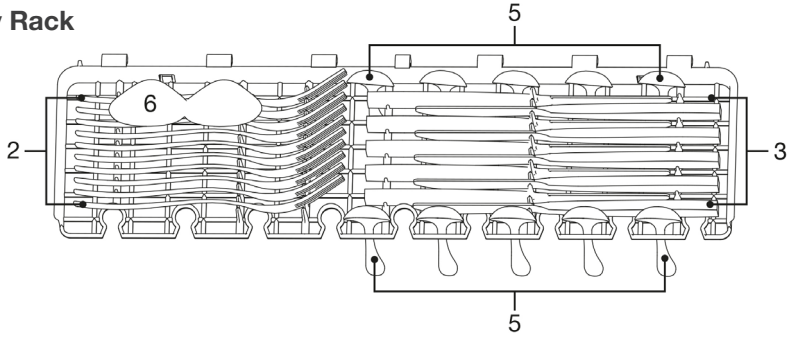

NOTE: Please place the light flat wares on the shelf. The total weight is less than 1.5kg.

Cutlery Basket

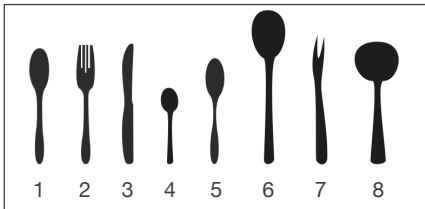
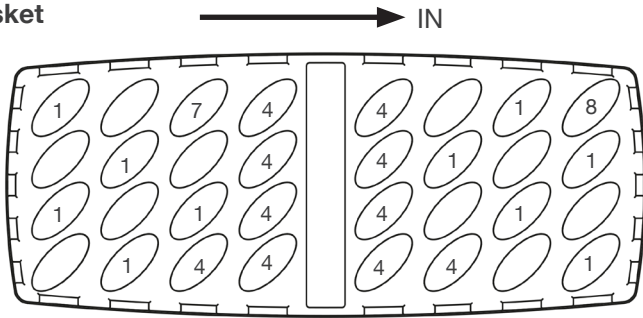

Number	Item
1	Soup Spoons
2	Forks
3	Knives
4	Teaspoons
5	Dessert Spoons
6	Serving Spoons
7	Serving Forks
8	Gravy Ladles

Information for comparability

tests in accordance with EN60436

Capacity: 10 place settings

Position of the upper basket: lower position

Program: ECO

Rinse aid setting: MAX

Softener setting: H3

Adjusting the Upper Rack

The height of the upper rack can be adjusted in order to create more space for large utensils both for the upper/lower rack. The height of the upper basket can be adjusted by placing the wheels on different height of the rails. Long items, serving cutlery, salad servers and knives should be placed on the shelf so that they do not obstruct the rotation of the spray arms.

Lower position



Upper position



Folding Back the Cup Shelves

For better stacking of pots and pans, the spikes can be folded down as shown in the pictures right.

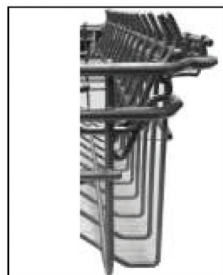
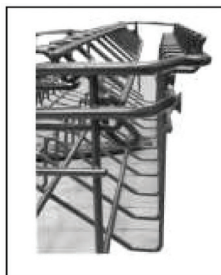

Folding Prongs of Lower Rack

For better stacking of pots and pans, the prongs can be folded down as shown in the picture right.



Cutlery Basket

Cutlery should be placed in the cutlery basket with the handles pointing down. If the rack has side baskets, the spoons should be loaded separately into the appropriate slots. Especially long utensils should be placed in the horizontal position at the front of the upper rack.

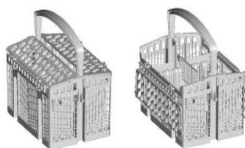

Warning: Do not let any item extend through the side or bottom of the cutlery basket. Always load sharp utensils with the sharp edge pointing down!

WASH CYCLE TABLE

The table below shows which programs are best for the levels of food residue left on the dishes and how much detergent is needed.

(●) Means: rinse aid must be added to the Rinse Aid Dispenser.

Program	Description of Cycle	Detergent Pre/Main	Running Time(min)	Energy (kWh)	Water (L)	Rinse Aid
 All in One	Wash (50°C) Rinse Rinse (70°C) Drying	$\frac{4/14g}{(1 \text{ piece})}$	215	0.78	10.1	●
 Intensive	Pre-Wash (50°C) Wash (65°C) Rinse Rinse Rinse (65°C) Drying	$\frac{4/14g}{(1 \text{ piece})}$	205	1.378	15.3	●
ECO (*EN 60436)	Wash (45°C) Rinse Rinse (60°C) Drying	$\frac{18g}{(1 \text{ piece})}$	235	0.755	9	●
 90 Min	Wash (60°C) Rinse Rinse (65°C) Drying	$\frac{18g}{(1 \text{ piece})}$	90	1.234	10.2	●
 Glass	Pre-Wash Wash (50°C) Rinse Rinse (65°C) Drying	$\frac{4/14g}{(1 \text{ piece})}$	120	0.934	13.1	●
 Soak	Pre-Wash		15	0.02	3.6	○

ECO : This program is the test cycle. The information for comparability test in accordance with EN60436.
(*EN 60436)

OPERATING INSTRUCTIONS

Starting a Cycle Wash

1. Ensure the water supply is switched on.
2. Insert the plug into the wall socket.
3. Pull out the lower and upper basket, load the dishes and push them back into place. It is recommended to load the lower basket first, then the upper one.
4. Pour in the detergent.
5. Close the door and press the Power button to switch on the machine.
6. Choose a program, the corresponding light will turn on. Then press the Start/Pause button and the dishwasher will start its cycle.

Changing the Program Mid-Cycle

A wash cycle can only be changed if it has been running for a short time. If it has been running for a while, the detergent may have already been released and the dishwasher may have already drained the water. If this is the case, the dishwasher needs to be reset and the detergent dispenser must be refilled. To reset the dishwasher, follow the instructions below:

1. Press the Start/Pause button to pause the washing.
2. Press Program button for more than 3 seconds - the program will cancel.
3. Press the Program button to select the desired program.
4. Press the Start/Pause button, after 10 seconds, the dishwasher will start.

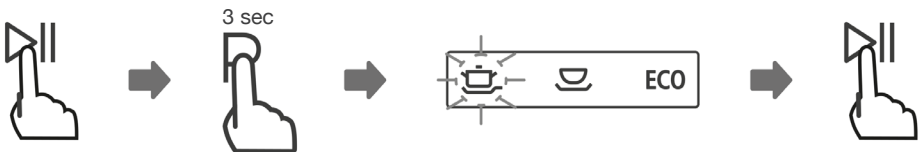

Forgot to Add a Dish?

A forgotten dish can be added any time before the detergent dispenser opens. If this is the case, follow the instructions below:

1. Press the Start/Pause button to pause the washing.
2. Wait 5 seconds then open the door.
3. Add the missed dishes.
4. Close the door.
5. Press the Start/Pause button and after 10 seconds the dishwasher will start.

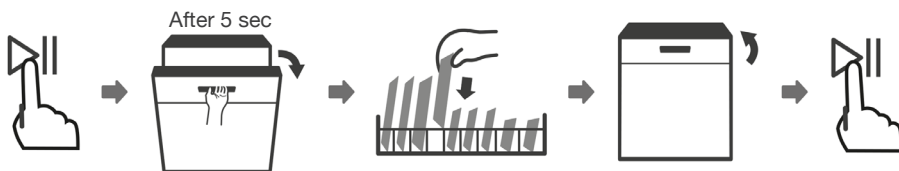

At the End of the Wash Cycle

When the wash cycle program has finished, the End Indicator will illuminate on the control panel and the buzzer will beep for 8 seconds and then stop.

- To turn off the dishwasher, press the ON/OFF button and then turn off the water supply. It is recommended that you wait at least 15 minutes before attempting to unload the dishwasher; this will allow the dishes to cool down. Open the door carefully, leaving it ajar for a few minutes and taking care to avoid the escaping steam.
- Empty the lower basket first and then the upper one. This will avoid water dripping from the upper rack onto the dishes in the lower one. (It is normal for the inside of the dishwasher to be wet inside)



Warning: Caution must be taken when opening the door during a wash cycle as hot water and escaping steam can scald

CLEANING AND MAINTENANCE

Frost Precaution

Please take frost protection measures on the dishwasher in winter. Every time after washing cycles, please operate as follows:

1. Cut off the electrical power to the dishwasher at the supply source.
2. Turn off the water supply and disconnect the water inlet pipe from the water valve.
3. Drain the water from the inlet pipe and water valve. (Use a pan to gather the water)
4. Reconnect the water inlet pipe to the water valve.
5. Remove the filter at the bottom of the tub and use a sponge to soak up water in the sump.

Shutting Off the Water and Electricity Supplies

- Turn off the water tap after every wash cycle to avoid leaks
- Always unplug the appliance when cleaning it and when performing maintenance work.

Cleaning the Dishwasher

- The external surfaces of the machine and the control panel can be cleaned using a non-abrasive cloth which has been dampened with water. Do not use solvents or abrasive products. After cleaning, wipe with a dry cloth.
- Any marks on the inside of the appliance may be removed using a cloth dampened with water and a little vinegar

Preventing Unpleasant Odours

- Always keep the door of the appliance ajar in order to avoid moisture from forming and being trapped inside the machine
- Clean the seals around the door and detergent dispensers regularly using a damp sponge. This will avoid food becoming trapped in the seals, which is the main cause behind the formation of unpleasant odours

Filtering System

The filtering system in the base of the wash cabinet retains coarse debris from the washing cycle. The collected coarse debris may cause the filters to clog. Check the condition of the filters regularly and clean them if necessary under running water. Follow the steps below to clean the filters in the wash cabinet.

Note: Pictures are only for reference, different models of the filtering system and spray arms may be different.

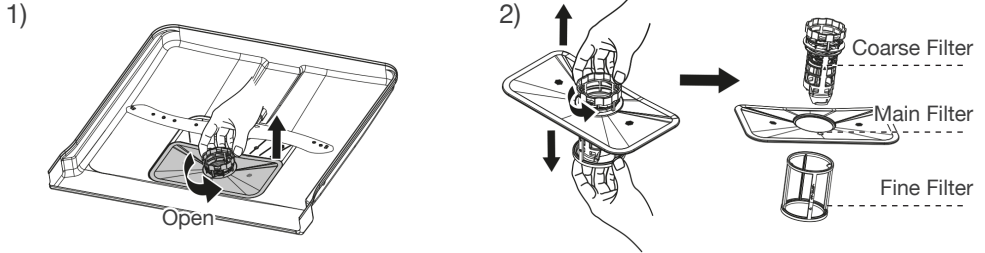

Hold the coarse filter and rotate it anticlockwise to unlock the filter. Lift the filter upwards and out of the dishwasher.

The fine filter can be pulled off the bottom of the filter assembly. The coarse filter can be detached from the main filter by gently squeezing the tabs at the top and pulling it away.

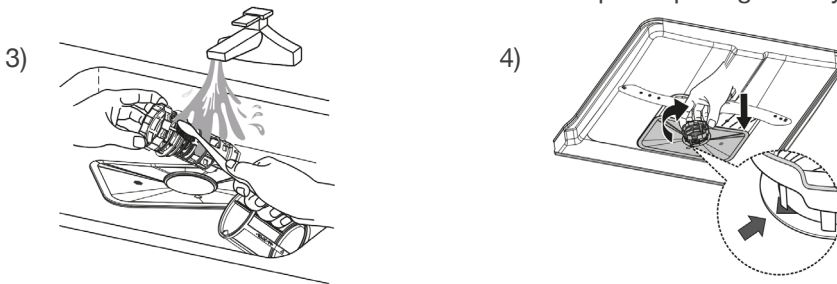

Larger food remnants can be cleaned by rinsing the filter under running water. For a more thorough clean, use a soft cleaning brush.

Reassemble the filters in the reverse order of the disassembly, replace the filter insert, and rotate clockwise to the close arrow.



Warning: Do not over tighten the filters. Put the filters back in sequence securely, otherwise coarse debris could get into the system and cause a blockage. Never use the dishwasher without filters in place. Improper replacement of the filter may reduce the performance level of the appliance and damage dishes and utensils.

Cleaning the Spray Arms

It is necessary to clean the spray arms regularly for hard water chemicals as they can clog the spray arm jets and bearings.

To clean the spray arms, follow the instructions below:

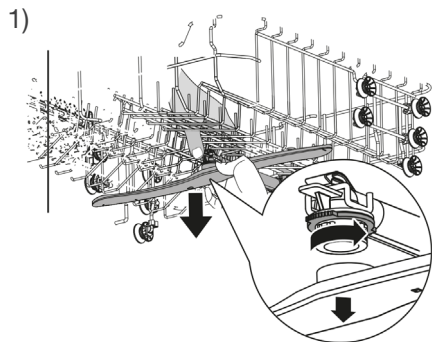

To remove the upper spray arm, hold the nut in the center still and rotate the spray arm counterclockwise to remove it.

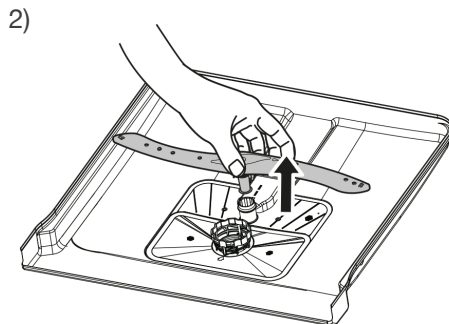

To remove the lower spray arm, pull the spray arm up.

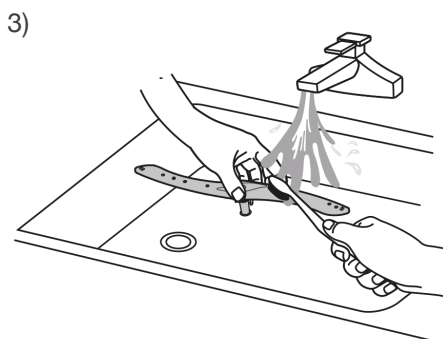

Wash the arms in soapy, warm water and use a soft brush to clean the jets. Replace them after rinsing them thoroughly.

Leaving the Machine Unused for Extended Periods

It is recommend that you run a wash cycle with the dishwasher empty and then remove the plug from the wall socket, turn off the water supply and leave the door of the appliance slightly ajar. This will help the door seals to last longer and prevent odours from forming within the appliance.

Moving the Appliance

If the appliance must be moved, try to keep it in the vertical position. If absolutely necessary, it can be positioned on its back.

TROUBLESHOOTING

If you are having problems with your appliance, please use our troubleshooting guide below. If you are unable to resolve the issue using this guide please ring our Customer Service Department on 0844 848 5861. Please have the model code and purchase information available.

Problem	Possible Cause	Possible Solution
Dishwasher doesn't start	Fuse blown, or the circuit break tripped.	Replace fuse or reset circuit breaker. Remove any other appliances sharing the same circuit with the dishwasher.
	Power supply is not turned on.	Make sure the dishwasher is turned on and the door is closed securely. Make sure the power cord is properly plugged into the wall socket.
	Water pressure is low	Check that the water supply is connected properly and the water is turned on.
	Door of dishwasher not properly closed.	Make sure to close the door properly and ensure that it is latched.
Water not pumped from dishwasher	Twisted or trapped drain hose.	Check the drain hose.
	Filter clogged.	Check the coarse filter.
	Kitchen sink clogged.	Check the kitchen sink to make sure it is draining well. If the problem is the kitchen sink and that is not draining, you may require a plumber rather than qualified technician.
Suds in the tub	Wrong detergent.	Only use designated dishwasher detergent to avoid suds. If this occurs, open the dishwasher and let the suds evaporate.
	Spilt rinse-aid.	Always wipe up rinse-aid spills immediately.
Stained tub interior	Detergent with colourant may have been used	Make sure that the detergent has no colourant.
White film on inside surface	Hard water minerals.	To clean the interior, use a damp sponge with dishwasher detergent whilst rubber gloves. Never use any other cleaner than dishwasher detergent otherwise it may cause foaming or formation of suds.

Problem	Possible Cause	Possible Solution
There are rust stains on cutlery	The affected items are not corrosion resistant.	Avoid washing items that are not corrosion resistant in the dishwasher.
	A program was not run after dishwasher salt was added. Traces of salt have gotten into the wash cycle.	Always run a wash program without any crockery after adding salt.
	The lid of the softer is loose.	Check the softener lid is secure.
Knocking noise in the dishwasher	A spray arm is knocking against an item in a basket	Interrupt the program and rearrange the items which are obstructing the spray arm.
Rattling noise in the dishwasher	Items of crockery are loose in the dishwasher.	Interrupt the program and rearrange the items of crockery.
Knocking noise in the water pipes	This may be caused by on-site installation or the cross-section of the piping.	This has no influence on the dishwasher function. If in doubt, contact a qualified plumber.
The dishes are not clean	The dishes were not loaded correctly.	See “RECOMMENDED LOADING OF RACKS”.
	The program was not powerful enough.	Select a more intensive program.
	Not enough detergent was dispensed.	Use more detergent, or change the detergent.
	Items are blocking the movement of the spray arms.	Rearrange the items so that the spray can rotate freely.
	The filter combination is not clean or is not correctly fitted in the base of wash cabinet. This may cause the spray arm jets to get blocked.	Clean and/or fit the filter correctly. Clean the spray arm jets.
Cloudiness on glassware	Combination of soft water and too much detergent.	Use less detergent if the water is soft and select a shorter cycle to wash the glassware thoroughly.

Problem	Possible Cause	Possible Solution
White spots appear on dishes and glasses.	Hard water area can cause limescale deposits.	Add more detergent.
Black or grey marks on dishes	Aluminium utensils have rubbed against dishes	Use a mild abrasive cleaner to eliminate those marks.
Detergent left in dispenser	Dishes block detergent dispenser	Re-load the dishes properly.
The dishes aren't drying	Improper loading	Load the dishwasher as suggested in the directions.
	Dishes are removed too soon	Open the door slightly so that the steam can escape. Take out the dishes when they are cool enough to touch. Unload the lower basket first to prevent water dropping onto the upper basket.
	Wrong program has been selected	With a short program, the washing temperature is lower, which therefore may decrease cleaning performance. Choose a program with a longer washing time.
	Use of cutlery with a low-quality coating.	Water drainage is more difficult with these items. Cutlery or dishes of this type are not suitable for washing in the dishwasher

ERROR CODES

If there is a malfunction, the dishwasher will display error codes to identify these:

Codes	Meanings	Possible Causes
E1	Longer inlet time.	Faucets is not opened, or water intake is restricted, or water pressure is too low.
E3	Not reaching required temperature.	Malfunction of heating element.
E4	Overflow.	Some element of dishwasher leaks.
ED	Failure of communication between main PCB with display PCB.	Open circuit or break wiring for the communication.



Warning: If overflow occurs, turn off the main water supply before calling a service. If there is water in the base pan because of an overflow or small leak, the water should be removed before restarting the dishwasher.

MAINS PLUG FUSE REPLACEMENT

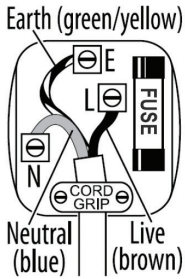

Fuse Replacement (Class I)

This appliance must be earthed. Remove the central screw on the plug and open the shell. Take out the fuse and replace with a new fuse of the same Amp. Install the shell again and tighten the screws.

DISPOSAL

The European Directive 2012/19/EU on Waste Electrical and Electronic Equipment (WEEE), requires that old household electrical appliances must not be disposed of in normal unsorted municipal waste.

Old appliances must be collected separately in order to optimise the recovery and recycling of the materials they contain and reduce the impact on human health and the environment.

The crossed out “wheeled bin” symbol on the product reminds you of your obligation, that when you dispose of the appliance it must be separately collected. Consumers should contact their local authority or retailer for information concerning the correct disposal of their old appliance.



STATESMAN

kitchen appliances

**38 Bluestem Road, Ransomes
Europark Ipswich, IP3 9RR**

**Castle Electrical Factors Ltd.,
Dundalk, A91 KA9R, IR**

0844 848 5861

Disclaimer: Statesman operate a policy of continual improvement and development.
We therefore reserve the right to change/alter the specification and appearance of our appliances without prior notice. All diagrams and images shown in this manual are for illustration purposes only.