

STATESMAN

kitchen appliances



FWM1914W
9KG WASHING MACHINE WHITE

Instruction Manual

**Please read these instructions carefully before use and retain for future reference.
Before switching on your appliance – always check for any damage that may have
been caused in transit.**

CONTENTS

Important Safety Instructions	3-7
Product Overview	8
Technical Specification	8
Product Fiche	9
Installation	10-13
- Unpacking the Washing Machine	11
- Remove Transport Bolts	12
- Levelling the Washing Machine	12
- Connect the Water Supply Hose	12-13
- Drain Hose	13
Operating Instructions	14-22
- Before First Use	14
- Before Each Wash	15
- Detergent Dispenser	16-17
- Control Panel	18
- Programmes	19-22
- Functions	23-24
Cleaning & Maintenance	25-27
Trouble Shooting Guide & Error Codes	28-29
Fuse Replacement	30
Disposal Information	31
Statesman Warranty Information	32

IMPORTANT SAFETY INSTRUCTIONS

This user manual contains important safety information and instruction on the operation and maintenance of your appliance. Please take the time to read this user manual before using your appliance and keep this book for future reference.

Safety Instructions

- If the supply cord is damaged, it must be replaced by the manufacturer, its service agent or similarly qualified persons in order to avoid a hazard.
- If the machine is damaged, it must not be operated unless repaired by the manufacturer, its service agent or similarly qualified persons.
- The appliance can be used by children aged from 8 years and above and persons with reduced physical, sensory or mental capabilities or lack of experience and knowledge if they have been given supervision or instruction concerning use of the appliance in a safe way and understand the hazards involved.
- Children shall not play with the appliance.
- Cleaning and user maintenance shall not be made by children without supervision.
- Children 3 years and under shall be kept away from the appliance or continuously supervised.
- Animals and children may climb into the machine. Check the machine before every use.
- Do not climb or sit on the appliance.

Installation

- Any washing powders, detergents, tablets or other such substances are to be kept in a safe place out of the reach of children.
- Do not install the machine on a carpeted floor to prevent any obstruction of openings which could damage the machine.
- Keep the appliance clear from any heat source and direct sunlight to avoid plastic and rubber parts corroding.

- Do not use the appliance in humid environments or rooms containing explosive or caustic gas.
- In case of water leakage or water splashes let the appliance dry in the open air.
- The appliance must not be installed behind a lockable door, a sliding door or a door with a hinge on the opposite side to that of the washing machine.
- Do not operate the machine in rooms with a temperature of below 5°C, as this could lead to certain parts being damaged. If it is unavoidable, make sure to drain the water completely from the appliance after every use (see the “Cleaning the Drain Pump Filter” section) to avoid damage caused by frost.
- Never use flammable sprays or substances in the immediate proximity of the appliance.
- Remove all packaging material and transport bolts before using the appliance, otherwise, serious damage may result.
- This appliance is equipped with a single inlet valve and can be connected to the cold water supply only.
- The mains plug must be accessible after installation.
- Before washing clothes for the first time, the machine should be run on the cotton programme at 60°C without any laundry or detergent inside.
- Before using the washing machine, the product shall be calibrated.
- Do not put any excessively heavy objects on the appliance, like water containers or heating devices.
- Ensure the new hose-sets supplied with the appliance are used and that any existing hose-sets are replaced.
- Max. Inlet water pressure 1 MPa. Min. inlet water pressure 0.05 MPa.

Electrical Connection



WARNING: Water and electrical connections must be carried out by a qualified technician in accordance with the manufacturer’s instructions and local safety regulations.

- Make sure the power cable is not trapped by the machine, as this could lead to damage.

- Connect the product to a grounded outlet, protected by a fuse complying with the values in the “Technical Specifications” table.
- The grounding installation has to be made by a qualified electrician.
- Ensure that the machine is installed in accordance with the local regulations.



WARNING:

- **Don't use multiple plugs or extension cords.**
- **The appliance must not have an external switching device such as a timer or be connected to a circuit that is regularly switched on and off.**
- **Do not remove the plug from the mains socket if there is flammable gas present.**
- **Never remove the plug with wet hands.**
- **Always remove by pulling the plug, not the cable.**
- **Always unplug the appliance if it is not being used.**

Water Connections



WARNING: Water and electrical connections must be carried out by a qualified technician in accordance with the manufacturer's instructions and local safety regulations.

- Check the connections of the water inlet tubes, the water tap and the outlet hose for possible problems due to changes in water pressure. If the connections loosen or leak, close the water tap and get it repaired. Do not use the appliance before the pipes and hoses are installed properly by a qualified technician.
- The glass door may become very hot during operation. Keep children and pets far away from the machine while it is in use.
- The water inlet and outlet hoses must be safely installed and remain undamaged, otherwise water leakage can occur.
- Do not remove the drain pump filter while there is still water in the appliance. Large quantities of water can leak out, and there is a risk of scalding due to hot water.

Operation & Maintenance

- Never use any flammable, explosive or toxic solvents. Do not use gasoline and alcohol etc. as detergents. Only select detergents that are suitable for machine washing.
- Make sure that all pockets are emptied. Sharp and rigid items such as coins, brooches, nails, screws, stones etc. may cause serious damage to this machine.
- Remove all objects from pockets such as lighters and matches before placing in the appliance.
- Thoroughly rinse items that have been washed by hand.
- Items that have been soiled with substances such as cooking oil, acetone, alcohol, petrol, kerosene, spot removers, turpentine, wax and wax removers should be washed in hot water with an extra amount of detergent before being washed in the appliance.
- Items containing foam rubber (latex foam), shower caps, waterproof textiles, rubber backed articles and clothes or pillows fitted with foam rubber pads should not be washed in the machine.
- Fabric softeners or similar products should be used as recommended by their instructions.
- Never try to open the door forcefully. The door will unlock shortly after the end of a cycle.
- Please do not close the door with excessive force. If it is difficult to close the door, please check if clothes are properly inserted and distributed within the drum.
- Always unplug the appliance and close the water tap before cleaning and maintenance and after each use.
- Never pour water over the appliance as there is a risk of electric shock.
- Repairs shall only be carried out by the manufacturer, its service agent, or a similarly qualified technician in order to avoid a hazard. The manufacturer will not be held responsible for any damages caused due to attempted repairs carried out by unqualified persons.

Transport

- Before transporting the appliance:
 - Transport bolts shall be reinstalled to the machine by a qualified technician.
 - Accumulated water shall be drained out of the machine.

Caution: This appliance is heavy. Transport with care. Never hold any protruding part of the machine when lifting. The machine door cannot be used as a handle.

Intended Use

- The product is intended only for home use and for textiles in household amounts suitable for the washing machine.
- This appliance is for indoor use only and is not intended for built in use.
- The appliance is not intended for commercial use.
- Only use according to these instructions.
- Any other use is considered improper use. The manufacturer is not responsible for any damage or injuries that may be caused as a result.
- This appliance is intended to be used in household and similar applications such as:
 - Staff kitchen areas in shops, offices and other working environments;
 - Farm houses;
 - By clients in hotels, motels and other residential type environments;
 - Bed and breakfast type environments;
 - Areas for communal use in blocks of flats or in launderettes.

PRODUCT OVERVIEW

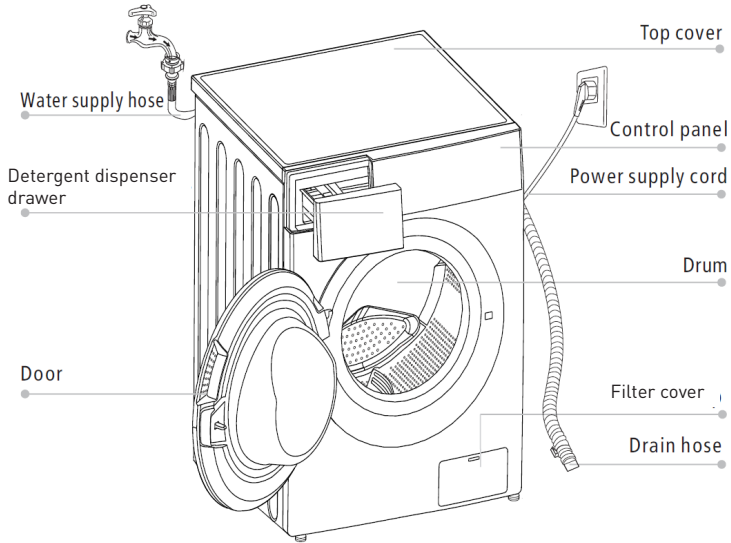

4 x Cover caps

1 x Supply hose cold water

1 x Owner's manual

Acoustic sponge (optional)

TECHNICAL SPECIFICATION

Model	FWM1914W
Power Supply	220-240V~, 50Hz
Max. Current	13A
Standard Water Pressue	0.05MPa~1MPa
Washing Capacity	9kg
Product Dimensions (mm)	H:847 x W:594 x D:560
Net Weight	61kg
Rated Power	1950W

PRODUCT FICHE

Supplier's name: Statesman				
Suppliers Address: 38 Bluestem Road, Ransomes Europark, Ipswich, Suffolk, IP3 9RR				
Model identifier: FWM1914W				
General product parameters:				
Parameter	Value	Parameter	Value	
Rated capacity ^(*) (kg)	9.0	Dimensions in cm ^(*) , ^(*)	Height	84.7
			Width	59.4
			Depth	56
Energy efficiency index ^(*) (EEI _w)	51.9	Energy efficiency class ^(*)	A	
Washing efficiency index ^(*)	1.031	Rinsing effectiveness ^(*) (kg) ^(*)	5.0	
Energy consumption in kWh per cycle, based on the ECO 40-60 programme. Actual energy consumption will depend on how the appliance is used.	0.494	Water consumption in litre per cycle, based on the ECO 40-60 programme. Actual water consumption will depend on how the appliance is used and on the hardness of the water.	50	
Maximum temperature inside the treated textile ^(*) (°C)	Rated capacity	43	Weighted remaining moisture content ^(*) (%)	53.9
	Half	33		
	Quarter	23		
Spin speed ^(*) (rpm)	Rated capacity	1350	Spin-drying efficiency class ^(*)	B
	Half	1350		
	Quarter	1350		
Programme duration ^(*) (h:min)	Rated capacity	3:48	Type	free-standing
	Half	2:54		
	Quarter	2:54		
Airborne acoustical noise emissions in the spinning phase ^(*) (dB(A) re 1 pW)	72	Airborne acoustical noise emissions class ^(*) (spinning phase)	A ^(*)	
Off-mode (W) (if applicable)	0.50	Standby mode (W) (if applicable)	1.00	
Delay start (W) (if applicable)	4.00	Networked standby (W) (if applicable)	N/A	
Minimum duration of the guarantee offered by the supplier ^(*) , ^(*) :				
This product has been designed to release silver ions during the washing cycle		NO		
Additional information:				
Weblink to the suppliers website, where the information in point 9 of Annex II to Commission Regulation (EU) 2019/2023 (1) is found:				
^(*) this item shall not be considered relevant for the purposes of Article 2(6) of Regulation (EU)2017/1369. ^(*) for the ECO 40-60 programme. ^(*) changes to this item shall not be considered relevant for the purposes of paragraph 4 of Article 4 of Regulation (EU) 2017/1369. ^(*) if the product database automatically generates the definitive content of this cell, the supplier shall not enter these data.				

INSTALLATION



WARNING:

- **Stability is important to prevent the product from moving.**
- **Make sure the machine is standing level and stable.**
- **Make sure that the product does not stand on the power cord.**
- **Make sure to maintain the minimum distance from the walls as shown in the picture below.**

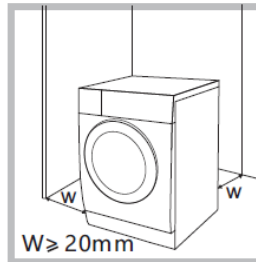

Before installing the machine, a location for installation characterized as follows, should be selected:

1. Firm and dry, with a level surface
2. Avoid direct sunlight
3. Sufficient ventilation
4. Room temperature is above 0°C
5. Keep far away from the heat sources such as coal or gas burning appliances.

Make sure to install the foam pads onto the base of the appliance. This can help to reduce noise caused by the machine while operating. To do this:

1. Lay the machine onto a side panel, placing a soft material such as foam or a cloth between the machine and the floor for protection.
2. Attach the foam pads to the base edges of the machine. The 2 longer pads to the 2 longer edges, and the 2 shorter pads to the 2 shorter edges.

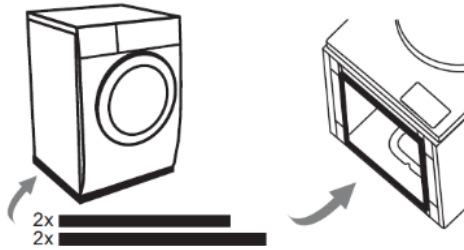

Unpacking the Washing Machine



WARNING: Packaging material (e.g. films, Styrofoam) can be dangerous. There is a risk of suffocation. Keep all packaging well away from children

1. Remove the cardboard box and Styrofoam packing.
2. Lift the washing machine and remove the base packaging. Make sure the small triangle of foam (a) is removed with the bottom packaging. If not, lay the unit down on a side panel and remove it manually.
3. Remove the inlet hose from the drum.
4. Remove the tape securing the power supply cord and drain hose.

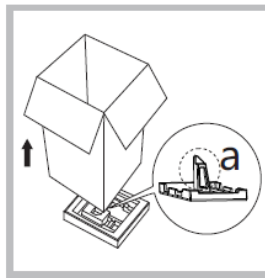

Remove Transport Bolts



WARNING: You must remove the transport bolts from the back of the machine before use.



Loosen the 4 transport bolts with a spanner.



Remove the bolts including the rubber parts and keep them for future use.

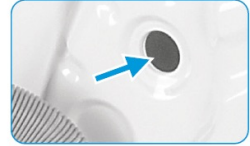

Close the holes using the cover caps.

Levelling the Washing Machine



WARNING: The lock nuts on all four feet must be screwed tightly against the housing.

1. Loosen the lock nut.
2. Turn the foot until it reaches the floor.
3. Adjust the legs and lock the nuts with a spanner. Make sure the machine is level and steady.

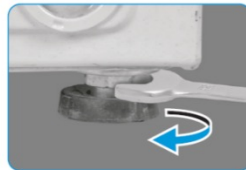

Connect the Water Supply Hose



WARNING: To prevent leakage or water damage, follow the instructions in this manual. Do not kink, crush or modify the water inlet hose.

Connect the water supply hose to the water inlet valve and a water tap with cold water as indicated.

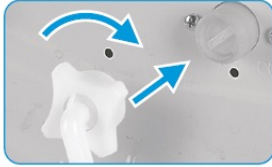

Please Note: Connect manually, do not use tools. Check if the connections are tight.

Drain Hose



WARNING: Do not kink or protract the drain hose. Position the drain hose properly, otherwise damage might be a result of water leakage.

There are two ways to connect the end of drain hose as show below:

1. Put it into the water trough.

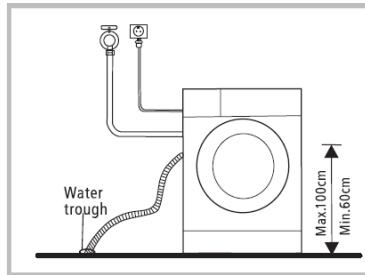

2. Connect it to the branch drain pipe of the trough.

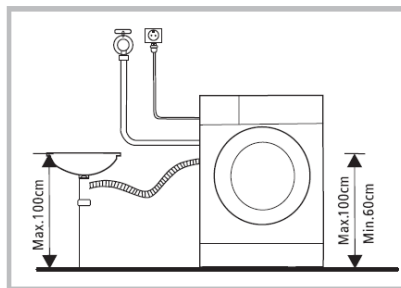

OPERATING INSTRUCTIONS

Before First Use

Caution: Before first use, please make sure the appliance is installed properly.

- Your appliance was thoroughly checked before it left the factory. To remove any residual water and to neutralise any potential odours, it is recommended to clean your appliance before first use. To do this, run the washing machine on the Cotton programme at 60°C without laundry and detergent.

Before Washing

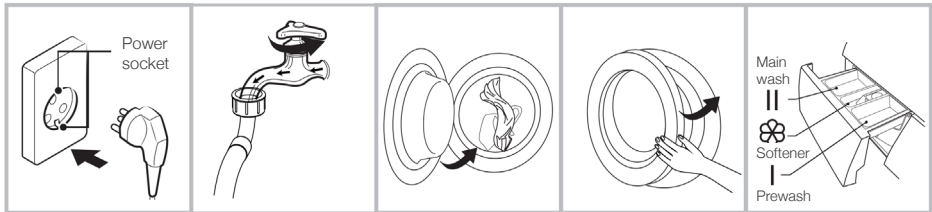

Please Note: Detergent only needs to be added into compartment I if the pre-wash function is selected.

Washing

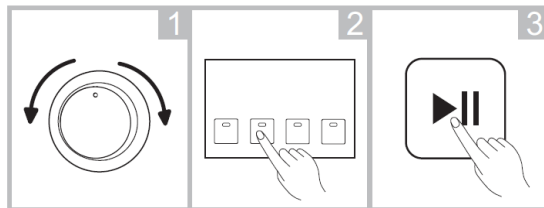

Select programme Select function or setting options Press Start/Pause to start the program

After Washing

An alert will sound, the door will lock and the Start/Pause indicator lights will flash.

Before Each Wash

- The ambient temperature of the washing machine should be 5-40°C. If used under 0°C, the inlet valve and draining system may be damaged. If the machine is installed in conditions below freezing, it should be transferred to a normal ambient temperature to ensure the water supply hose and drain hose can unfreeze before use.
- Please check your laundry care labels and the detergent instructions before washing. Use non-foaming or less-foaming detergent suitable for machine washing.

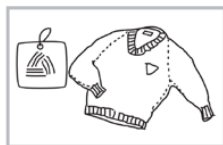

Check the care label

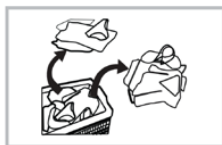

Sort laundry according to color and textile type

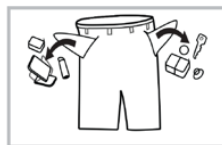

Take all items out of pockets

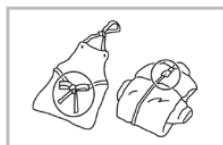

Tie together long textile strips and belts, close zips and buttons



Put small items into a laundry bag



Turn easy-piling and long-pile fabric inside out



WARNING:

- **Do not wash or dry articles that have been cleaned in, washed in, soaked in, or dabbed with combustible or explosive substances like wax, oil, paint, gasoline, alcohol, kerosene, and other flammable materials.**
- **Washing single clothes items may easily cause the machine to be unbalanced. Therefore, it is recommended to add one or two more laundry items into the wash so that the spin can be done smoothly.**

Detergent Dispenser

- I Pre wash
- II Main wash
- ☼ Softener
-  Detergent dispenser drawer release button

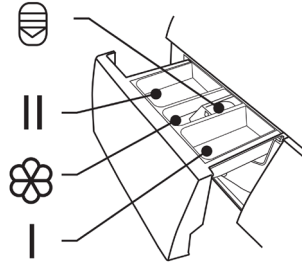

CAUTION! Detergent only needs to be added into compartment I after selecting pre-wash function.

Programme	I	II	☼
Quick 15'		●	○
Rapid 45'		●	○
20°C		●	○
Jeans	○	●	○
ECO 40-60		●	○
Bulky	○	●	○
Rinse & Spin			○
Spin Only			

Programme	I	II	☼
Baby Care	○	●	○
Wool		●	○
Mixed	○	●	○
Synthetic	○	●	○
Sports	○	●	○
Cotton	○	●	○
Steam Wash	○	●	○

● : Required ○ : Optional

Detergent Recommendation

Recommended washing detergent	Wash Cycles	Washing temp.	Type of laundry and textile
Heavy-duty detergent with bleaching agents and optical brighteners	Cotton, ECO 40-60	40/60	White laundry made from boil-proof cotton or linen
Colour detergent without bleaching agent and optical brighteners	Cotton	20/40	Coloured laundry made from cotton or linen
Colour or mild detergent without optical brighteners	Cotton, Synthetic	20/40	Coloured laundry made from easy care fibres or synthetic materials
Mild washing detergent	Synthetic	20	Delicate textiles, silk, viscose
Special wool detergent	Wool	20/40	Wool

- Thick or concentrated detergent can be diluted in some water before pouring into the detergent dispenser, to avoid the inlet becoming blocked and causing water to overflow.
- Please choose the suitable type of detergent to ensure maximum washing performance and minimum water and energy consumption.
- To achieve the best cleaning result, use the appropriate dose of detergent.
- Use a reduced detergent amount if the drum is not filled.
- Always adjust the amount of detergent to the water hardness, if your tap water is soft, use less detergent.
- Dose according to how dirty your laundry is, less dirty clothes require less detergent.
- Highly concentrated (compact detergent) requires particularly accurate dosing.

The following symptoms are a sign of detergent overdosing:

- heavy foam formation
- poor washing and rinsing result

The following symptoms are a sign of detergent underdosing:

- laundry turns grey
- build-up of limescale deposits on the drum, the heating element and/or the laundry

Control Panel

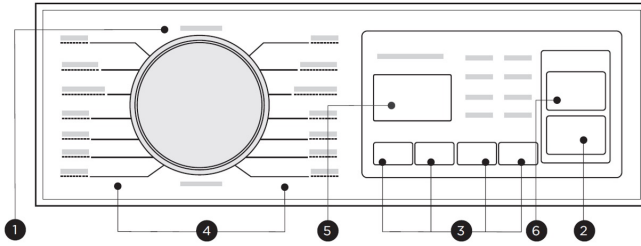

1	Off: Turn the appliance on and off.	4	Programmes: Available according to the laundry type.
2	Start/Pause: Start or pause your programme.	5	Display: The display shows settings, estimated remaining time, options and status messages.
3	Options: This allows you to select additional functions and will light when selected.	6	Drum Clean: Sets the machine to clean the drum and tube.

Display

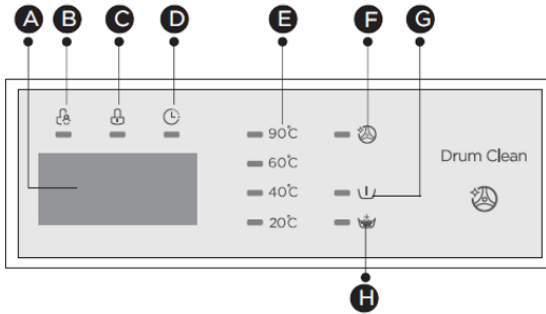

A Display

Wash Time
1:25
Speed
400
End
End

Delay Time
2H
Error
E30

B Child Lock

C Door Lock

D Delay

E Temp.

F Drum Clean

G Pre Wash

H Extra Rinse

Programmes

Important: If there is any break in the power supply while the machine is operating, a special memory stores the selected programme. The machine will continue the programme when the power supply is re-established.

Programme	Washing/Drying Load (kg)	Display Time (H)
	9.0	9.0
Quick 15'	2.0	0:15
Rapid 45'	2.0	0:45
20°C	4.5	1:01
Jeans	9.0	1:40
ECO 40-60	9.0	3:48
Steam Wash	4.5	1:48
Rinse & Spin	9.0	0:20
Spin Only	9.0	0:12
Baby Care	9.0	1:42
Wool	2.0	1:07
Bulky	9.0	1:48
Mixed	9.0	1:20
Synthetic	4.5	1:58
Sports	4.5	0:47
Cotton	9.0	1:28
Drum Clean	0	1:18

































Cycle	Nominal capacity (kg)	Temperature setting	Cycle duration (H:M)	Energy consumption (kWh / operating cycle)	Water consumption (L / operating cycle)	Highest temperature (°C)	Residual moisture (% / spin speed)
Cotton	9.0	60	1:43	1.603	78	60	53%/1400
Mix	9.0	40	1:20	0.813	78	40	65%/1000
20°C	4.5	20	1:01	0.189	48	20	65%/1000
Baby Care	9.0	60	1:42	1.423	78	60	65%/1000
Quick 15'	2.0	Cold	0:15	0.030	31	Cold	75%/800
ECO 40-60 ³	9.0	-	3:48	0.865	63	43	53.9%/1350
	4.5	-	2:54	0.452	49	33	53.9%/1350
	2.0	-	2:54	0.205	39	23	53.9%/1350

- The above data is for reference only, and the data may change due to different actual use conditions.
 - The values given for programmes other than the ECO 40-60 programme are indicative only.
 - The new EU energy efficiency class is A. Energy test programme: ECO 40-60. Speed: the highest speed; Other as the default.
 - Half load for 9.0kg machine: 2.5kg.
1. The highest temperature reached by the laundry in the wash cycle for at least 5 minutes.
 2. Residual moisture after the wash cycle in water content percent and the spin speed at which this was achieved.
 3. The ECO 40-60 programme is able to clean normally soiled cotton laundry declared to be washable at 40°C or 60°C, together in the same cycle. This programme is used to assess the compliance with the regulation (EU) 2019/2023.

The most efficient programmes in terms of energy consumption are generally those that perform at lower temperatures and for longer durations. Loading the washing machine up to the capacity indicated for the respective programmes will contribute to energy and water savings. Noise and remaining moisture content are influenced by the spinning speed: the higher the spinning speed in the spinning phase, the higher the noise and the lower the remaining moisture content.

Programmes are available according to the laundry type.

PROGRAMMES	DESCRIPTIONS
Cotton	Use for washing hard-wearing textiles, heat-resistant textiles made of cotton or linen.
Rapid 45'	Use for washing few and not very dirty clothes quickly.
Synthetic	Use for washing synthetic articles, for example: shirts, coats, blending. While washing knitted textiles, detergent quantity should be reduced due to its loose string construction and easily forming bubbles.
Baby Care	Use for washing baby's clothes. Additional rinsing ensures excess detergent that could be irritating to baby's skin is removed from laundry.
Jeans	Use for washing jeans.
Mixed	Use for washing mixed loads.
20°C	Use for washing brightly colored clothes as it can protect the colors better.
Sports	Use for washing active wear.
Quick 15'	Extra short programme which is suitable for washing small amounts of lightly soiled laundry.
Bulky	This programme is specifically designed for washing bulky items.
Wool	Use for washing hand or machine-washable wool or rich wool textiles. Especially gentle wash programme to prevent shrinkage, longer programme pauses (textiles rest in washing liquid).
Spin Only	Extra spin with selectable spin speed.
Rinse & Spin	Extra rinse with spin.
ECO 40-60	Use for washing brightly colored clothes as it can protect the colors better. Default 40°C, not selectable, suitable for laundry washing at about 40°C-60°C.
Steam Wash	The steam wash can deeply penetrate the fibres, which effectively eliminates bacteria and germs, preventing odours and protecting health.
Drum Clean	This function is set to clean the drum and tubes. It applies 90°C high temperature sterilization. When this programme is used, the washing cannot be added. A chlorine bleaching agent can be used with this programme. This programme can be used regularly.

Cycle	Default Temp (°C)	Default Spin Speed (rpm)	Additional Functions
Steam Wash	40	1000	 ,  , 
Cotton	40	1000	 ,  , 
Synthetic	40	800	 ,  , 
Mix	40	1000	 ,  , 
Jeans	40	800	 ,  , 
ECO 40-60	40	1400	
20°C	20	1000	 , 
Spin Only	--	1000	
Rinse & Spin	--	1000	 , 
Bulky	40	1000	 ,  , 
Baby Care	60	1000	 ,  , 
Wool	40	600	 , 
Sport Wear	20	800	 ,  , 
Rapid 45'	20	800	 , 
Quick 15'	Cold	800	
Drum Clean	90	--	

Please Note: For the maximum spin speed, programme time, and other details of the ECO 40-60 programme, please refer to the content on the Product Fiche page.

Functions

Spin

Spin Speed: Press this button to change the spin speed between; 0-400-600-800-1000-1200-1400.

Delay

Delay: Set the washing machine to start at a delayed time of 0-24 hours.



Choose programme



Setting time



Start

1. Select a programme.
2. Press the [Delay] button to choose the delaying time.
3. Press [Start/Pause] to start the delay operation.
4. To cancel the Delay function, press the [Delay] button before starting the programme. If the programme has already been started, switch off the programme to set a new one.



Pre Wash: The Pre-wash function provides an extra wash before the main wash. Detergent should be added to compartment I when selecting this function.



Extra Rinse: The laundry will undergo an extra rinse when selected.

Drum Clean

Drum Clean: Use this function to clean the machine. Once the machine has been run 25 times the Drum Clean indicator will flash. Once the drum clean programme has been run, the usage counter will begin re-counting.

To cancel the drum clean reminder, press and hold the Drum Clean button for 3 seconds. The reminder will be cancelled and washing cycles will be recounted for another 25 cycles.

Temp.

Temp: Press to adjust the washing temperature between; Cold - 20°C - 40°C - 60°C - 90°C.



Child Lock: Lock the machine to avoid mis-operation by children. To turn on press [Temp.] and [Function] simultaneously for 3 seconds until the buzzer beeps. The child lock indicator will

turn on. The Child Lock deactivates all function buttons except the Child Lock button.

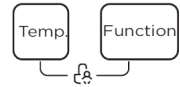

When the Child Lock is activated, the display will alternately display “CL” and the remaining programme time. Pressing any other button will cause the Child Lock indicator to flash for 3 seconds. Only pressing the [Temp.] and [Function] simultaneously can deactivate the Child Lock. The child lock will need to be deactivated to select a new programme.



Mute: To mute the machines sounds, press the [Spin] button for 3 seconds. Once muted the machines sounds will not be activated. To un-mute the machine, press the [Spin] button again for 3 seconds.



Choose the Programme



Press the [Spin] button for 3sec., the buzzer is mute.



Reload: When a cycle is in progress, use this function to pause the programme and add additional items to the wash.

1. Press the [Start/Pause] button for 3 seconds. Wait for the drum to stop rotating, and for the door to unlock.
2. Add additional items into the machine and close the door.
3. Press the [Start/Pause] button to resume the programme.



Press[3s for Reload]3sec.



Reload the clothes



Start

Usage Counter

1. Unplug the appliance for 10 seconds and then reconnect to the power.
2. Turn on the machine and within 10 seconds, simultaneously press the [Delay] and [Drum Clean] buttons for 5 seconds or until the device displays a value. The value indicates the number of times the machine has been used.
3. Repeat step 1 to resume normal operation.

CLEANING & MAINTENANCE



WARNING: Always unplug the appliance and close the water tap before cleaning and maintenance.

Cleaning the Cabinet

Proper maintenance of the washing machine can extend its working life. The surface can be cleaned with diluted non-abrasive neutral detergents when necessary. If there is any water overflow, use a cloth to wipe it off immediately. Never use sharp items to clean the appliance.



WARNING: Never use abrasive or caustic agents, formic acids or its diluted solvents or similar substances, like alcohol or chemical products to clean the appliance.

Cleaning the Drum

Any rust stains left inside the drum by metal articles must be removed immediately using chlorine-free detergents. Never use steel wool for cleaning the drum.

Please Note: Keep any laundry away from the machine while cleaning the drum.

Cleaning the Door Seal and Glass

Wipe the glass and seal after each wash to remove lint and stains. If lint builds up it can cause leakages. Remove any coins, buttons and other objects from the seal after each wash. Clean the door seal and glass every month to ensure normal operation of the appliance.

Cleaning the Inlet Filter

Please Note: Diminishing water flow is a sign that the filter needs to be cleaned.

1. Close the tap and remove the water supply hose from it.
2. Clean the filter with a brush.
3. Unscrew the water supply hose from the rear of the machine. Pull out the filter with long nose pliers.
4. Use a brush to clean the filter.
5. Reinstall the filter to the water inlet and reconnect the water supply hose.
6. Clean the inlet filter every 3 months to ensure the normal operation of the appliance.

Clean the Detergent Dispenser

1. Press down the release button (⊖) located on the softener cover and pull the dispenser drawer free from the recess. Clean the inside of the recess with a brush.
2. Remove the softener cover from the dispenser drawer and wash both parts thoroughly with water.
3. Restore the softener cover onto the drawer and replace the drawer back into position.

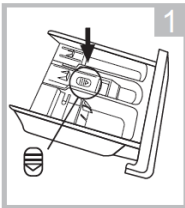

Press the release button and remove the dispenser drawer

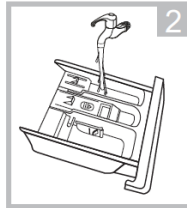

Clean the dispenser drawer and the softener cover with water

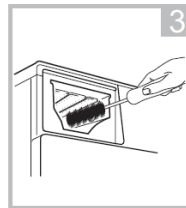

Clean the recess with a soft brush

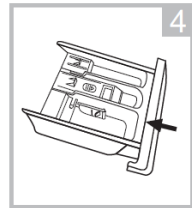

Replace the dispenser drawer

Please Note:

- Do not use abrasive or caustic agents to clean plastic parts.
- Clean the detergent dispenser every 3 months to ensure the normal operation of the appliance.

Cleaning the Drain Pump Filter



WARNING:

- **Make sure that the machine has finished the washing cycle and is empty. Switch off and unplug before cleaning the drain pump filter.**
- **Be careful of hot water, there is a risk of scalding. Allow water to cool down.**
- **Clean the filter periodically every 3 months to ensure the normal operation of the appliance.**
- **Make sure the drain hose cap and the drain hose are reinstalled properly, otherwise water may leak.**

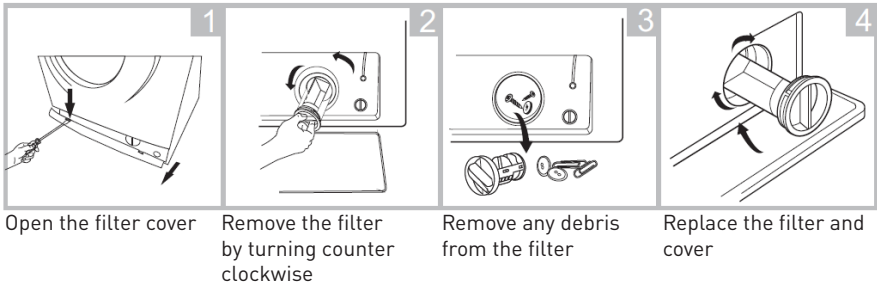

Transporting the Appliance

- Unplug the appliance and close the water inlet tap.
- Check the door and detergent dispenser are closed properly.
- Remove the water inlet pipe and the outlet hose from the house installations.
- Let the water drain completely from the appliance (see the “Cleaning the Drain Pump Filter” section).
- **Important:** Re-install the 4 transport bolts on the back of the appliance.
- The appliance is heavy, transport with care. Never hold any protruding part of the machine when lifting. The machine door cannot be used as a handle.

TROUBLE SHOOTING GUIDE

If you are having problems with your appliance, please use our trouble shooting guide below. If you are unable to resolve the issue using this guide, please ring our Customer Service Department on 01473 277 508. Please have the model code and purchase information available.

DESCRIPTION	POSSIBLE CAUSE	SOLUTION
Appliance does not start	Door is not closed properly.	Close the door properly and restart.
	Clothes are stuck.	Check the laundry.
Door can't be opened	Safety protection is activated.	Disconnect the power and restart.
Water leakage	Connections are not tight enough.	Check and fasten the water inlet pipe. Check and clean the outlet hose.
Detergent residues in the detergent dispenser	Detergent is damp and/or clotted.	Clean and dry the detergent dispenser.
Indicator or display does not work	PC board or harness have connection problems.	Switch off the power and check if the mains plug is connected properly.
Abnormal noise	Transport bolts still in place.	Check if the transport bolts have been removed.
	Floor is not solid or level.	Make sure the appliance is installed on a solid and level floor.

Error Codes

DESCRIPTION	POSSIBLE CAUSE	SOLUTION
E30	Door is not closed properly.	Restart after the door is closed. Check if the clothes are stuck.
E10	Water injecting problem during wash cycle.	Check if the water pressure is too low. Straighten the water pipe. Check if the inlet valve filter is blocked.
E21	Overtime water draining.	Check the drain hose for blockage.
E12	Water overflow.	Restart the appliance.
EXX	Others.	Restart the appliance. If problem persists, please contact customer service.



WARNING:

- **Never try to repair an appliance that is defective or presumed to be defective.**
- **You may put your own and future users' lives in danger. Only authorised technicians are allowed to carry out this repair work.**
- **Improper repair will void the warranty and subsequent damages won't be covered.**

FUSE REPLACEMENT

Fuse Replacement (Class I)

This appliance must be earthed. Remove the fuse cover with a small flat head screw driver. Take out the fuse and replace with a new fuse of the same Amp. Replace the fuse cover and push back into place.

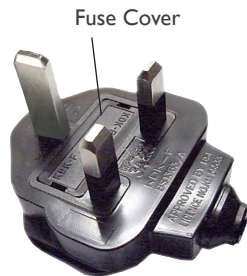

DISPOSAL INFORMATION

The European Directive 2002/96/EC on Waste Electrical and Electronic Equipment (WEEE), requires that old household electrical appliances must not be disposed of in normal unsorted municipal waste. Old appliances must be collected separately in order to optimise the recovery and recycling of the materials they contain and reduce the impact on human health and the environment. The crossed out “wheeled bin” symbol on the product reminds you of your obligation, that when you dispose of the appliance it must be separately collected. Consumers should contact their local authority or retailer for information concerning the correct disposal of their old appliance.



STATESMAN WARRANTY/GUARANTEE TERMS & CONDITIONS

THANK YOU FOR CHOOSING STATESMAN

As a valued customer we would like to offer you a **FREE 2-year warranty** to cover your product against any electrical or mechanical defects.

This means that in the unlikely event you develop a fault or problem with your product we will happily repair or replace the item free of charge.

To qualify for the guarantee, the product must be used for domestic household use only and in accordance with the instructions in the user manual. Any misuse of the product will result in the warranty being void.

The guarantee does not cover accidental damage, misuse, neglect, tampering or incorrect adjustment or installation.

The guarantee will be rendered invalid if the product is resold, has had its serial number or rating label removed (or has an invalid serial number or rating label), or if an unauthorised person has carried out any repairs or alterations.

The warranty does not cover accessories or consumable parts that require replacement under normal use. This includes shelving, dials, filters, belts and trays etc.

In the unlikely event of a breakdown please refer to the Troubleshooting Guide in your user manual and check all plugs, fuses and the electricity supply.

If you still require assistance, please contact our Customer Service Department on **01473 277 508** or write to us at the following address:

**Customer Service Department
38 Bluestem Road, Ransomes Industrial Estate, Ipswich, IP3 9RR**

Please quote the Product Code and the PO number on the rating label and give details of the exact fault. We will then decide whether to replace the item.

IMPORTANT NOTE: Before we arrange the replacement, you will be required to return a copy of your proof of purchase. Please retain your original.

If an item is replaced within the agreed warranty period, the warranty for the replacement item will be calculated from the purchase date of the original.

In the event that the product is inspected, and no fault is found, or the product is not within the guarantee period you will be charged for the repair and any carriage costs.

STATESMAN
— kitchen appliances

**38 Bluestem Road, Ransomes Europark, Ipswich, IP3 9RR
EU: Castle Electrical Factors Ltd., Dundalk, A91 KA9R, IR**

01473 277 508