

# STATESMAN

kitchen appliances

---



**SKMC0930SB/SKMC0930SS**  
**30L 900W DIGITAL COMBINATION MICROWAVE**  
**BLACK/SILVER**

## Instruction Manual

Please read these instructions carefully before use and retain for future reference. Before switching on your appliance – Always check for any damage that may have been caused in transit.

## CONTENTS

Important Safety Instructions .....	3-8
Product Specification.....	8
Appliance Overview.....	9-10
Installation.....	11
Operating Instructions.....	12-18
Cleaning & Maintenance.....	19
Trouble Shooting Guide .....	20
Mains Plug Fuse Replacement.....	21
Disposal Information.....	21
Statesman Warranty/Guarantee Information.....	22

## PRECAUTIONS TO AVOID POSSIBLE EXPOSURE TO EXCESSIVE MICROWAVE ENERGY

- (a) Do not attempt to operate this oven with the door open since this can result in harmful exposure to microwave energy. It is important not to break or tamper with the safety interlocks.
- (b) Do not place any object between the oven front face and the door or allow soil or cleaner residue to accumulate on sealing surfaces.
- (c) If the door or door seals are damaged, the oven must not be operated until it has been repaired by a competent person.
- (D) The oven should not be adjusted or repaired by anyone except qualified service personnel.

## IMPORTANT SAFETY INSTRUCTIONS

To reduce the risk of fire, electric shock, injury to persons or exposure to excessive microwave oven energy when using your appliance, follow basic precautions, including the following:

- Read all instructions before using the appliance and keep for future reference.
- Use this appliance only for its intended use as described in the manual. Do not use corrosive chemicals or vapours in this appliance. This type of oven is specifically designed to heat, cook or dry food. It is not designed for industrial or laboratory use.
- Do not operate the oven when empty.
- Do not operate this appliance if it has a damaged cord or plug, if it is not working properly, or if it has been damaged or dropped. If the supply cord is damaged, it must be replaced by the manufacturer or its service agent or a similarly qualified person in order to avoid a hazard.



**WARNING!** Only allow children to use the oven without supervision when adequate instructions have been given so that the child is able to use the oven in a safe way and understands the hazards of improper use.



**WARNING!** When the appliance is operated in the combination mode, children should only use the oven under adult supervision due to the temperatures generated.

- To reduce the risk of fire in the oven cavity:
  - When heating food in plastic or paper containers keep an eye on the oven due to the possibility of ignition.
  - Remove wire twist-ties from paper or plastic bags before placing bags into the oven.
  - If smoke is observed, switch off or unplug the appliance and keep the door closed in order to stifle any flames.
  - Do not use the cavity for storage purposes. Do not leave paper products, cooking utensils, or food in the cavity when not in

use.

- The microwave oven is intended for heating food and beverages. Drying of clothing and heating of warming pads, slippers, sponges, damp cloth and similar may lead to risk of injury, ignition or fire.



**WARNING!** Liquid or other food must not be heated in sealed containers since they are liable to explode.

- Microwave heating of beverages can result in delayed eruptive boiling; therefore, care has to be taken when handling the container.
- Do not fry food in the oven. Hot oil can damage oven parts and utensils and even result in skin burns.
- Eggs in their shell and whole hard-boiled eggs should not be heated in microwave ovens since they may explode even after microwave heating has ended.
- Pierce foods with heavy skins such as potatoes, whole squashes, apples, and chestnuts before cooking.
- The contents of feeding bottles and baby jars should be stirred or shaken and the temperature should be checked before serving in order to avoid burns.
- Cooking utensils may become hot because of heat transferred from the heated food. Potholders may be needed to handle the utensil.
- Utensils should be checked to ensure that they are suitable for use in a microwave oven.

**WARNING!** It is hazardous for anyone other than a trained



person to carry out any service or repair operation which involves the removal of any cover which gives protection against exposure to microwave energy.

- This Microwave complies with EN 55011/CISPR 11, in this standard it belong to Class B Group 2 classification. Group 2 equipment: group 2 contains all ISM RF equipment in which radio-frequency energy in the frequency range 9 kHz to 400 GHz is intentionally generated and used or only used locally, in the form of electromagnetic radiation, inductive and/or capacitive coupling, for the treatment of material, for inspection/

analysis purposes, or for transfer of electromagnetic energy. Class B equipment is equipment suitable for use in locations in residential environments and in establishments directly connected to a low voltage power supply network which supplies buildings used for domestic purposes.

- This appliance is not intended for use by persons (including children) with reduced physical, sensory or mental capabilities, or lack of experience and knowledge, unless they have been given supervision or instruction concerning use of the appliance by a person responsible for their safety.
- Children should be supervised to ensure that they do not play with the appliance.
- The microwave oven should only be used as freestanding.

 **WARNING!** Do not install oven over a range cooktop or other heat-producing appliance. This could cause damage and would invalidate the warranty.

- The microwave oven must not be placed in a cabinet.
- The door or the outer surface may get hot when the appliance is operating.

 **WARNING!** Accessible parts may become hot during use. Young children should be kept away.

- During use the appliance becomes hot. Care should be taken to avoid touching heating elements inside the oven.

 **WARNING!** If the door or door seals are damaged, the oven must not be operated until it has been repaired by a competent person.

- The appliances are not intended to be operated by means of an external timer or separate remote-control system.
- The microwave oven is for household use only and not for commercial use.
- Never remove the distance holder in the back or on the sides, as it ensures a minimum distance from the wall for air circulation.
- Please secure the turntable before you move the appliance to avoid damage.

 **WARNING!** It is hazardous for anyone other than a competent person to carry out any service or repair operation that involves the removal of a cover which gives protection against exposure to microwave energy.

- The microwave oven is intended for defrosting, cooking and steaming of food only.
- Use gloves if you remove any heated food.

 **WARNING!** Steam will escape when opening lids or wrapping foil.

- This appliance can be used by children aged from 8 years and above and persons with reduced physical, sensory or mental capabilities or lack of experience and knowledge if they have been given supervision or instruction concerning use of the appliance in a safe way and understand the hazards involved.
- Children shall not play with the appliance. Cleaning and user maintenance shall not be made by children unless they are aged from 8 years and above and supervised.
- If smoke is emitted, switch off or unplug the appliance and keep the door closed in order to stifle any flames.
- Please ensure that the grounding electrode of the power socket is equipped with a reliable grounding line.

 **WARNING:** Improper use of the grounding plug can result in a risk of electric shock.

## UTENSILS

### **CAUTION:** Personal Injury Hazard

It is hazardous for anyone other than a competent person to carry out any service or repair operation that involves the removal of a cover which gives protection against exposure to microwave energy.

See the instructions on “Materials you can use in microwave oven or to be avoided in microwave oven.” There may be certain non-

metallic utensils that are not safe to use for microwaving. If in doubt, you can test the utensil in question following the procedure below.

### Utensil Test:

- Fill a microwave-safe container with 1 cup of cold water (250ml) along with the utensil in question.
- Cook on maximum power for 1 minute.
- Carefully feel the utensil. If the empty utensil is warm, do not use it for microwave cooking.
- Do not exceed 1 minute cooking time

### Materials you can use in a microwave oven

Browning dish	Follow manufacturer’s instructions. The bottom of browning dish must be at least 3/16 inch (5mm) above the turntable. Incorrect usage may cause the turntable to break.
Dinnerware	Microwave-safe only. Follow manufacturer’s instructions. Do not use cracked or chipped dishes.
Glass jars	Always remove lid. Use only to heat food until just warm. Most glass jars are not heat resistant and may break.
Glassware	Heat-resistant oven glassware only. Make sure there is no metallic trim. Do not use cracked or chipped dishes.
Oven cooking bags	Follow manufacturer’s instructions. Do not close with metal tie. Make slits to allow steam to escape.
Paper plates and cups	Use for short-term cooking/warming only. Do not leave oven unattended while cooking.
Paper towels	Use to cover food for reheating and absorbing fat. Use with supervision for a short-term cooking only.
Parchment paper	Use as a cover to prevent splattering or a wrap for steaming.
Plastic	Microwave-safe only. Follow the manufacturer’s instructions. Should be labelled “Microwave Safe”. Some plastic containers soften, as the food inside gets hot. “Boiling bags” and tightly closed plastic bags should be slit, pierced or vented as directed by package.

Plastic wrap	Microwave-safe only. Use to cover food during cooking to retain moisture. Do not allow plastic wrap to touch food.
Thermometers	Microwave-safe only (meat and candy thermometers).
Wax paper	Use as a cover to prevent splattering and retain moisture.

### Materials to be avoided in microwave oven

Aluminium tray	May cause arcing. Transfer food into microwave-safe dish.
Food carton with metal handle	May cause arcing. Transfer food into microwave-safe dish.
Metal or metal-trimmed utensils	Metal shields the food from microwave energy. Metal trim may cause arcing.
Metal twist ties	May cause arcing and could cause a fire in the oven.
Paper bags	May cause a fire in the oven.
Plastic foam	Plastic foam may melt or contaminate the liquid inside when exposed to high temperature.
Wood	Wood will dry out when used in the microwave oven and may split or crack.

## PRODUCT SPECIFICATION

Power Supply	220-240V/50Hz
Power Consumption (Microwave)	1400W
Power Consumption (Grill)	1250W
Power Consumption (Convection)	2200W
Rated Microwave Power Output	900W
Operation Frequency	2450MHz
Outside Dimensions	300mm(H)×539mm(W)×449mm(D)
Oven Cavity Dimensions	223mm(H)×354mm(W)×362mm(D)
Oven Capacity	30 Litres
Net Weight	19kg



## APPLIANCE OVERVIEW

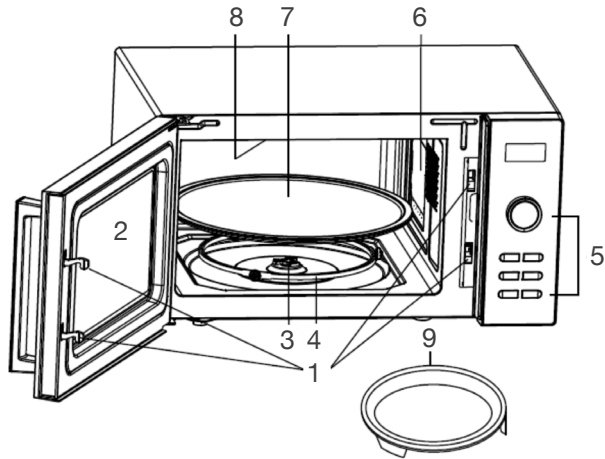

1. Door Safety Lock System
2. Oven Window
3. Shaft
4. Roller Ring
5. Control Panel
6. Wave Guide  
(Please do not remove the mica plate covering the wave guide)
7. Glass Tray
8. Grill Heater
9. Grill Pan

## Control Panel

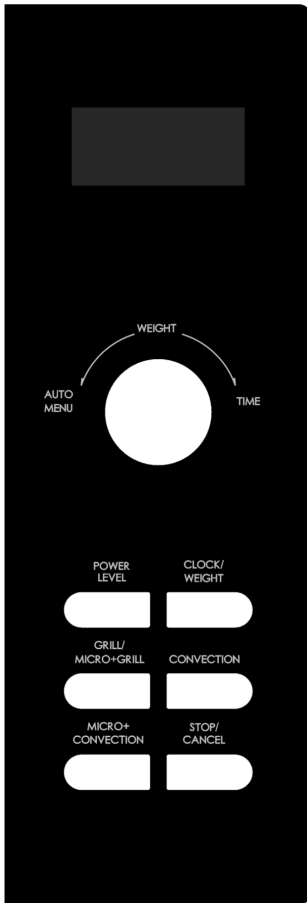

- **DISPLAY**  
Time, power and indicators are displayed.
- **AUTO MENU/WEIGHT/TIME (dial)**  
Turn the dial to set time, food weight or servings.  
Turn the dial to select auto cooking menus.
- **START/QUICK START (the dial)**  
Press the dial to start cooking programmes.  
Simply press the dial a number of times to set cooking time and cook immediately at full power level.
- **POWER LEVEL**  
Press to set microwave cooking power level.
- **CLOCK/WEIGHT**  
Press to set clock time.  
Press to set food weight or servings.
- **GRILL/MICRO+GRILL**  
Press to set grill cooking programme.  
Press to set microwave and grill combination cooking programme.
- **CONVECTION**  
Press to set convection cooking programme.
- **MICRO+CONVECTION**  
Press to set microwave and convection combination cooking programme.
- **STOP/CANCEL**  
Press once to temporarily stop cooking or twice to cancel cooking altogether.

# INSTALLATION

1. Make sure that all the packing materials are removed from the inside of the door.

**WARNING!** Check the oven for any damage, such as misaligned or bent door, damaged door seals and sealing surface, broken or loose door hinges and latches and dents inside the cavity or on the door. If there is any damage, do not operate the oven and contact qualified service personnel.



2. This microwave oven must be placed on a flat, stable surface to hold its weight and the heaviest food likely to be cooked in the oven.
3. Do not place the oven where heat, moisture, or high humidity are generated, or near combustible materials.
4. For correct operation, the oven must have sufficient airflow. Allow minimum 20cm of free space necessary above the top surface of the oven and 5cm at both sides. The microwave oven rear plate must be placed close to the wall. Do not cover or block any openings on the appliance. Do not remove feet.
5. Do not operate the oven without glass tray, roller support, and shaft in their proper positions.
6. Make sure that the power supply cord is undamaged and does not run under the oven or over any hot or sharp surfaces.
7. The socket must be readily accessible so that it can be easily unplugged in an emergency.
8. Do not use the oven outdoors.
9. Place the oven as far away from radios and TV as possible. Operation of microwave oven may cause interference to your radio or TV reception.
10. This appliance must be grounded. This oven is equipped with a cord having a grounding wire with a grounding plug. It must be plugged into a wall socket that is properly installed and grounded. In the event of an electrical short circuit, grounding reduces risk of electric shock by providing an escape wire for the electric current. It is recommended that a separate circuit serving only the oven be provided. Using a high voltage is dangerous and may result in fire or other accidents or damage.



**WARNING!** Improper use of the grounding plug can result in a risk of electric shock.

**Please Note:** If you have any questions about the grounding or electrical instructions, consult a qualified electrician or service person. Neither the manufacturer nor the dealer can accept any liability for damage to the oven or personal injury resulting from failure to observe the electrical connection procedures.

## OPERATING INSTRUCTIONS

- When the oven is first plugged in, a beep will sound, and the display will show "1:00".
- In the process of setting, after around 30 seconds of no activity, the oven will return to standby mode.
- During cooking, press STOP/CANCEL button once, to pause the programme, then press START/QUICK START button again to resume. If the STOP/CANCEL button is pressed twice, the programme will be cancelled.
- After cooking ends, the display will show "End" and a beep will sound every two minutes until the user presses STOP/CANCEL button or opens the door.
- The appliance has an automatic cooling function. When cooking time is above 2 minutes, once complete the oven fan will continue to work for about 3 minutes automatically to cool the oven down.

### Setting the Clock

This is a 12 or 24 hour clock. To set:

1. In standby mode, press CLOCK/WEIGHT button once or twice to set 12-or 24-hour clock.
2. Turn AUTO MENU/WEIGHT/TIME dial to set hour digit.
3. Press CLOCK/WEIGHT or START/QUICK START button once.
4. Turn AUTO MENU/WEIGHT/TIME dial to set minute digit.
5. Press CLOCK/WEIGHT or START/QUICK START button to confirm.

**NOTE:** During cooking, you can check the current clock time by pressing CLOCK/WEIGHT button.

### Microwave Cooking

1. In standby mode, press POWER LEVEL button repeatedly to set the cooking power level as below:

Press POWER LEVEL button	Power (Display)
Once	100% (P100)
Twice	80% (P-80)
3 times	60% (P-60)
4 times	40% (P-40)
5 times	20% (P-20)
6 times	0% (P-00)

2. Turn AUTO MENU/WEIGHT/TIME dial to set cooking time. The longest time is 95 minutes.
3. Press START/QUICK START button to confirm.

**NOTE:** During cooking or pausing, you can check the power level by pressing POWER LEVEL button. If you want to cook at the full power level, directly turn AUTO MENU/WEIGHT/TIME dial clockwise to set cooking time, then press START/QUICK START button to start.

### **Express Cooking**

Use this feature to programme the oven to microwave food at 100% power conveniently. In standby mode, press START/QUICK START button once (default cooking time is 30 seconds). The oven starts cooking automatically at full power. During cooking you can press START/QUICK START button repeatedly to add cooking time, each press will increase the time by 30 seconds, up to 10minutes.

### **Grill**

Grill cooking is particularly useful for thin slices of meat, steaks, chops, kebabs, sausages and pieces of chicken. It is also suitable for hot sandwiches and au gratin dishes.

1. In standby mode, press GRILL/MICRO+GRILL button once.
2. Turn AUTO MENU/WEIGHT/TIME dial to set cooking time. The longest time is 95 minutes.
3. Press START/QUICK START button to confirm.

## Microwave + Grill

**Combination 1:** 30% of time for microwave cooking, 70% for grill cooking. Use for fish, potatoes or au gratin.

**Combination 2:** 55% of time for microwave cooking, 45% for grill cooking. Use for pudding, omelettes, baked potatoes and poultry.

1. In standby mode, press GRILL/MICRO+GRILL button twice or 3 times to select combination 1 “Co-1” or combination 2 “Co-2”.
2. Turn AUTO MENU/WEIGHT/TIME dial to set cooking time. The longest time is 95 minutes.
3. Press START/QUICK START button to confirm.

## Convection

During convection cooking, hot air is circulated throughout the oven cavity to brown and crisp foods quickly and evenly. This oven can be programmed at ten different cooking temperatures:

(200°C → 190°C → 180°C → 170°C → 160°C → 150°C → 140°C → 130°C → 120°C → 110°C)

### To Preheat and Cook with Convection:

Your oven can be programmed to combine preheating and convection cooking operations.

1. In standby mode, press CONVECTION button repeatedly to set temperature.
2. Press START/QUICK START button once to confirm. The appliance will beep once it reaches the designated temperature.
3. Open the door and place the container of food at the centre of the turntable.
4. Turn AUTO MENU/WEIGHT/TIME dial to set cooking time. The longest time is 95 minutes.
5. Press START/QUICK START button to start.

**NOTE:** The longest preheat time is 30 minutes, and it cannot be set. When the oven reaches the preheat temperature, the oven will beep every 5 seconds for 30 minutes. The programme will end automatically if there is no operation within the 30 minutes.

## To Cook with Convection:

1. In standby mode, press the CONVECTION button repeatedly to set the temperature.
2. Turn AUTO MENU/WEIGHT/TIME dial to set cooking time. The longest time is 95 minutes.
3. Press START/QUICK START button to start.

**NOTE:** During cooking, you can check the current temperature by pressing CONVECTION button.

## Microwave + Convection

This oven has four pre-programmed settings that make it easy to cook with both convection heat and microwave automatically.

1. In standby mode, Press MICRO+CONVECTION button repeatedly to set convection temperature:  
(200°C → 170°C → 140°C → 110°C)
2. Turn AUTO MENU/WEIGHT/TIME dial to set cooking time. The longest time is 95 minutes.
3. Press START/QUICK START button to confirm.

**NOTE:** During cooking, you can check the combination power level by pressing MICRO+CONVECTION button.

## Weight Defrost

1. In standby mode, turn AUTO MENU/WEIGHT/TIME dial anti-clockwise until the display shows code "A-09".
2. Press START/QUICK START button once.
3. Press CLOCK/WEIGHT button or turn AUTO MENU/WEIGHT/TIME dial to set food weight. The weight ranges from 100g to 1800g.
4. Press START/QUICK START button to confirm.

**NOTE:** During defrosting, the system will pause to remind you to turn food over, after this, press START/QUICK START button to resume.

## Multi-Stage Cooking

Your oven can be programmed for up to two automatic cooking sequences. Suppose you want to set the following cooking programme:

Microwave cooking



Grill cooking

1. Input the microwave cooking programme. Do not press START/QUICK START button.
2. Input the grill cooking programme.
3. Press START/QUICK START button to start.

**NOTE:** Weight defrost, express cooking and auto cook menus cannot be set in the multistage cooking programme.

## Auto Cook

For the following food or cooking mode, it is not necessary to programme the cooking time and power. It is sufficient to indicate the type of food that you wish to cook as well as the weight or servings of this food.

Code	Menu	Note
A-01	Beverage (200 ml/cup, 1~3 cups)	<ol style="list-style-type: none"><li>1. For Beverage, Potato, Grilled Bread and Yogurt, the display will not show the icon “g”.</li><li>2. For Grilled Chicken, during cooking, the system will pause to remind you to turn food over, then press START/QUICK START button to resume.</li><li>3. The result of auto cooking depends on factors such as voltage fluctuation, the shape and size of food, your personal preference as to the doneness of certain foods and even how well you happen to place food in the oven. If you find the result at any rate not quite satisfactory, please adjust the cooking time a little bit accordingly.</li></ol>
A-02	Spaghetti (100 g, 200 g, 300 g)	
A-03	Rice (150~600 g)	
A-04	Reheat (200~800 g)	
A-05	Potato (230±10 g/serving, 1~2 servings)	
A-06	Grilled Chicken (800~1400 g)	
A-07	Pizza (150 g, 300 g, 450 g)	
A-08	Cake (475 g)	
A-10	Grilled Bread	
A-11	Yogurt	



## **Auto Cook Menus:**

### **For codes “A-01”-”A-08”:**

1. In standby mode, turn AUTO MENU/WEIGHT/TIME dial anti-clockwise to set menu code.
2. Press START/QUICK START button once.
3. Press CLOCK/WEIGHT button or turn AUTO MENU/WEIGHT/TIME dial to set food weight or servings.
4. Press START/QUICK START button to start.

### **For code”A-10”:**

1. In standby mode, turn AUTO MENU/WEIGHT/TIME dial anti-clockwise until the display shows code “A-10”.
2. Press START/QUICK START button once to start preheating, open and close the oven door once or press STOP/CANCEL button after preheating.
3. Press START/QUICK START button to start.

### **For code”A-11”:**

1. In standby mode, turn AUTO MENU/WEIGHT/TIME dial anti-clockwise until the display shows code “A-11”.
2. Press START/QUICK START button to start.

## **Child Lock**

The childproof lock prevents unsupervised operation by children. To enter child lock: In standby mode, after one minute without any operation the oven will automatically enter child lock mode. In the lock state, all buttons are disabled. Press any button or turn AUTO MENU/WEIGHT/TIME dial, the display will show “Loc” for 3 seconds to remind user to cancel the child proof lock.

To cancel the child lock: In child lock mode, open or close the oven door once to cancel the child lock.

## **Button Adhesion Protection**

In any state, if any button on the control panel is pressed down for 60 seconds, the programme stops working immediately, the display shows “FAIL” and a beep will sound. Any button is invalid at this time. After troubleshooting, press STOP/CANCEL button to return to standby mode.

## Automatic Protection

**Overheating Protection** - When the system enters super high temperature protection status, the digital display shows “E01”and continues to beep. After troubleshooting, press STOP/CANCEL button once, the system comes back to normal standby mode.

**Low Temperature Protection** - When the system enters low temperature protection status, the digital display shows “E02”and continues to beep. After pressing STOP/CANCEL button, the system comes back to normal standby mode.

**Sensor Malfunction Protection** - The system enters protection mode when the system sensor is short circuited. The display shows “E03”and continues to beep. After pressing STOP/CANCEL button, the system comes back to normal standby mode.

## CLEANING & MAINTENANCE

1. Turn off the oven and unplug the power cord from the wall when cleaning.
2. Keep the inside of the oven clean. When food splatters or is spilled liquids adhere to the oven walls, wipe with a damp cloth. Mild detergents may be used if the oven gets very dirty. Avoid using spray or other harsh cleaners. They may stain, streak or dull the door surface.
3. The outside of the oven should be cleaned with a damp cloth. To prevent damage to the operating parts inside the oven, water should not be allowed to seep into the ventilation openings.
4. Wipe the door and window on both sides. Clean the door seals and adjacent parts frequently with a damp cloth to remove any spills or splatters. Do not use abrasive cleaners.
5. A steam cleaner should not be used.
6. Do not allow the control panel to become wet. Clean with a soft, damp cloth. When cleaning the control panel, leave oven door open to prevent oven from accidentally turning on.
7. If steam accumulates inside or around the outside of the oven door, wipe with a soft cloth. This may occur when the microwave oven is operated under high humidity condition, and it is normal.
8. It is occasionally necessary to remove the glass tray for cleaning. Wash the tray in warm soapy water or put in a dishwasher.
9. The roller ring and oven floor should be cleaned regularly to avoid excessive noise. Simply wipe the bottom surface of the oven with mild detergent. The roller ring may be washed in mild, soapy water or in a dishwasher. When removing the roller ring, be sure to replace it in the correct position.
10. Remove odours from your oven by combining a cup of water with the juice and skin of one lemon in a microwaveable bowl. Microwave for 5 minutes. Wipe thoroughly and dry with a soft cloth.
11. If the light bulb burns out, please contact customer service to have it replaced.
12. The oven should be cleaned regularly, and any food deposits should be removed. Failure to maintain the oven in a clean condition could lead to deterioration of surfaces that could adversely affect the life of the unit and could possibly result in a hazardous situation.
13. When the microwave oven with grill function is first used, it may produce a slight smell and smoke. This is a normal phenomenon, because the oven is made of a steel plate coated with lubricating oil, the new oven will produce fumes and odour generated by burning the lubricating oil. This phenomenon will disappear after a period of using.

## TROUBLE SHOOTING GUIDE

If you experience difficulties with the appliance, please check the suggestions below before contacting customer services on 01473 277 508:

<b>Normal</b>	
Microwave oven interfering with TV reception	Radio and TV reception may be interfered with when the microwave oven is operating. It is similar to the interference of small electrical appliances, like food mixers, vacuum cleaners and electric fans. It is normal.
Dim oven light	In low power microwave cooking, the oven light may become dim. It is normal.
Steam accumulating on door, hot air out of vents	During cooking steam may be produced. Most will escape through the vents, but some may accumulate on cooler surfaces like the oven door. It is normal.
Oven started accidentally with no food inside	It is dangerous to run the microwave without any food inside. Turn off immediately.

Problem	Possible Cause	Possible Solution
Oven cannot be started	Power cord not plugged in tightly	Unplug, then plug in again after 10 seconds
	Fuse blown	Replace fuse or reset circuit breaker (the oven should not be repaired by anyone except qualified service personnel)
	Trouble with outlet	Test outlet with other electrical appliances
Oven does not heat	Door not closed properly	Close door properly

## MAINS PLUG FUSE REPLACEMENT

### Fuse Replacement (Class I)

This appliance must be earthed. Remove the fuse cover with a small flat head screw driver. Take out the fuse and replace with a new fuse of the same Amp. Replace the fuse cover and push back into place.



## DISPOSAL OF OLD ELECTRICAL APPLIANCES

The European Directive 2002/96/EC on Waste Electrical and Electronic Equipment (WEEE), requires that old household electrical appliances must not be disposed of in normal unsorted municipal waste. Old appliances must be collected separately in order to optimise the recovery and recycling of the materials they contain and reduce the impact on human health and the environment. The crossed out “wheeled bin” symbol on the product reminds you of your obligation, that when you dispose of the appliance it must be separately collected. Consumers should contact their local authority or retailer for information concerning the correct disposal of their old appliance.

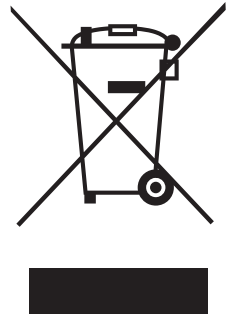

## STATESMAN WARRANTY/GUARANTEE TERMS & CONDITIONS

### THANK YOU FOR CHOOSING STATESMAN

As a valued customer we would like to offer you a **FREE 2-year warranty** to cover your product against any electrical or mechanical defects.

This means that in the unlikely event you develop a fault or problem with your product we will happily repair or replace the item free of charge.

To qualify for the guarantee, the product must be used for domestic household use only and in accordance with the instructions in the user manual. Any misuse of the product will result in the warranty being void.

The guarantee does not cover accidental damage, misuse, neglect, tampering or incorrect adjustment or installation.

The guarantee will be rendered invalid if the product is resold, has had its serial number or rating label removed (or has an invalid serial number or rating label), or if an unauthorised person has carried out any repairs or alterations.

The warranty does not cover accessories or consumable parts that require replacement under normal use. This includes shelving, dials, filters, belts and trays etc.

In the unlikely event of a breakdown please refer to the Troubleshooting Guide in your user manual and check all plugs, fuses and the electricity supply.

If you still require assistance, please contact our Customer Service Department on **01473 277 508** or write to us at the following address:

**Customer Service Department  
38 Bluestem Road, Ransomes Industrial Estate, Ipswich, IP3 9RR**

Please quote the Product Code and the PO number on the rating label and give details of the exact fault. We will then decide whether to replace the item.

**IMPORTANT NOTE: Before we arrange the replacement, you will be required to return a copy of your proof of purchase. Please retain your original.**

**If an item is replaced within the agreed warranty period, the warranty for the replacement item will be calculated from the purchase date of the original.**

In the event that the product is inspected, and no fault is found, or the product is not within the guarantee period you will be charged for the repair and any carriage costs.



**STATESMAN**  
kitchen appliances

**38 Bluestem Road, Ransomes Europark, Ipswich, IP3 9RR  
EU: Castle Electrical Factors Ltd., Dundalk, A91 KA9R, IR**

**01473 277 508**